





2

Sidewalks

Boston is known as a great walking city. Like many older cities, it was designed with the pedestrian in mind, with sidewalks and street trees along most of its streets; neighborhoods within walking distance of corner stores and commercial centers; and varied street fronts that provide interesting routes and inviting destinations. Sidewalk character is a key contributor to the identity of Boston's neighborhoods. As transit is within walking distance of virtually every place in the city, Boston is well suited for healthy, active transportation built around walking.

Sidewalk Design Principles

A major goal of these sidewalk guidelines is to enhance Boston's legacy as a great walking city by providing a physical framework that encourages people to walk as part of their everyday routine. Walking is an integral part of every trip, whether it is a walk to a friend's house, to the T, from the parking lot to the grocery store, or to work after parking a bicycle. Boston's sidewalks are a part of every trip, big or small, and are essential pieces of infrastructure. Sidewalks must be recognized not as a pedestrian amenity, but as the foundation of Boston's transportation network.

An equally important goal is to enhance the vitality of Boston's streets as public spaces. To encourage people to linger, sidewalks need to be safe, comfortable, and attractive, with facilities that provide accommodations for people of all ages and abilities. Lively sidewalks become venues for people to participate in face-to-face activities, support businesses, and to use new innovations in digital technology to interact with the public realm.

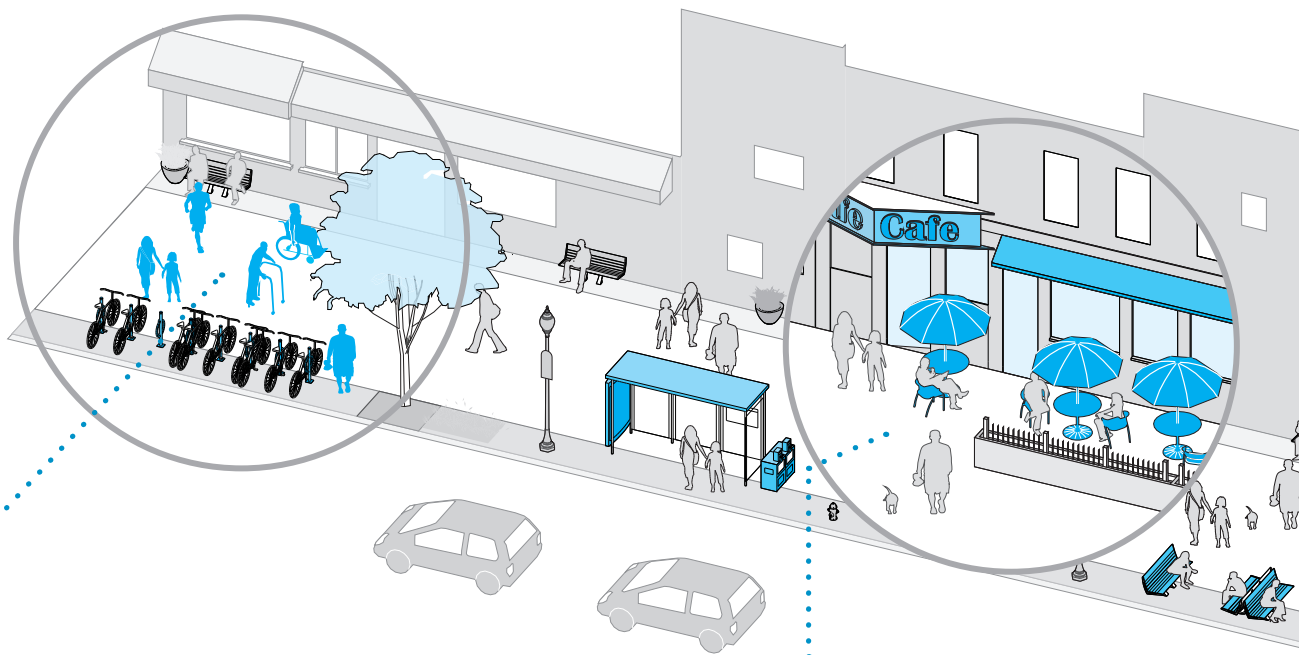

Accessible to All

Sidewalks must be safe and accessible for all users, regardless of physical abilities or age. They should be welcoming to people in wheelchairs, those pushing strollers, and those with carts or suitcases. Sidewalks should have continuous and unobstructed pathways and sight lines.

All-Weather Access

Sidewalks should be designed to provide storage for snow in winter, and graded to eliminate stormwater "ponding," especially at transitions and ramps. Shade trees should be provided for comfort during warmer months, and bus shelters for inclement weather.

Vibrant Walking Environment

Sidewalks should be comfortable, human-scaled, and vibrant with public art, cafés, benches, trees, awnings, and signage. They should be designed with inviting building entrances and transparent shop windows.

The Boston Public Works Department (PWD) is responsible for the management of publicly-owned sidewalks. All sidewalk designs must be approved by PWD in coordination with the Mayor's Commission for Persons with Disabilities. Maintenance agreements with abutters are required when non-standard materials or installation details are used.

These guidelines set high standards for accessibility, safety, environmental performance, and aesthetics in sidewalk design. In all cases these guidelines should be viewed as the minimum design criteria for all sidewalk construction and reconstruction in the City of Boston. However, it is also recognized that sidewalk construction often occurs in constrained environments where narrow rights-of-way, utilities, steep grades, and historic streets are key factors to consider when designing accessible sidewalks.

Sidewalks also occupy valuable space that can be used to support healthy trees and manage stormwater. The benefits of a robust tree canopy run the gamut from reducing stress to improving air quality.

Ease of Maintenance

Sidewalks should be durable and built with time-tested materials and features. They should be sustainable using locally-sourced and recycled materials where feasible. Maintenance responsibilities must be identified during the design process with a focus on reducing labor-intensive operations.

Intelligent Systems

Sidewalks should be fitted with smart-infrastructure networks such as fiber-optic cables and “smart” tags, like radio frequency identification (RFID) tags or quick response (QR) barcodes, to create opportunities for people to access local place-based information. Sensors and tags should be considered in designs to monitor air quality and noise, and to obtain real-time information, such as for trash and recycling collection and the condition of street lights.

Stormwater Management

Sidewalks should be designed to divert stormwater to soil rather than to pipes wherever possible. They should include, where appropriate and maintainable, features such as rain gardens, permeable paving, and simple ways to treat runoff from roadway and sidewalk surfaces.

Efficient Technologies

Sidewalk designs should incorporate state of the art technology to maximize efficiency. Energy-efficient features such as solar-powered trash compactors and light-emitting diode (LED) street lights should be considered in all designs.

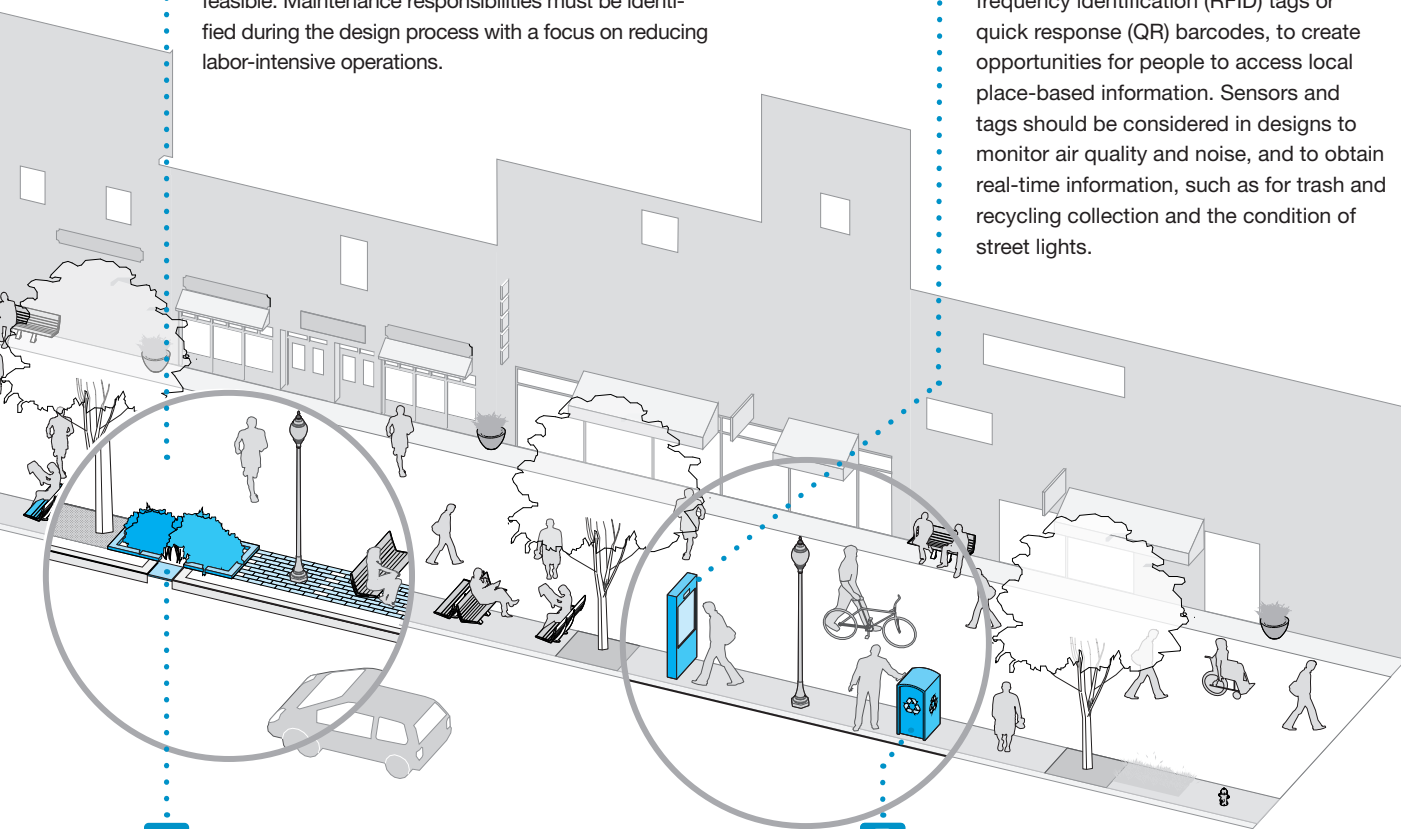

Sidewalk Zones



Curb Greenscape/Furnishing Zone Pedestrian Zone Frontage Zone

The primary objective in designing sidewalks in Boston’s constrained public right-of-way is to provide a continuous system of safe, accessible pathways for pedestrians on both sides of all streets.

Sidewalks should keep as much as possible to the natural path of travel, parallel to the roadway. Ideally, they will be located in a position that naturally aligns with crosswalks at intersections. It may be desirable in some locations for the sidewalk to curve to form a more direct route to an intersecting walkway, to preserve significant trees, or to provide a greater degree of separation between the sidewalk and the road.

Sidewalks immediately adjacent to high-volume pedestrian generators require special consideration. This includes sidewalks adjacent to transit stations, universities, major tourism and entertainment venues, and major destinations.

From the perspective of Complete Streets, the sidewalk consists of four parts: the **Frontage Zone**, the **Pedestrian Zone**, the **Greenscape/Furnishing Zone**, and the **Curb Zone**. Although the boundaries between them can sometimes be blurred, each zone serves a distinct purpose in a Complete Street. Dividing the sidewalk into four distinct parts ensures that each will be given the detailed attention required to make the whole work together as an integrated system.

The Frontage Zone is the area between the Pedestrian Zone and the streetwall. In locations where buildings are adjacent to the sidewalk, the Frontage Zone provides a buffer for pedestrians from opening doors and architectural elements. The Frontage Zone is the space for sidewalk cafés, store entrances, retail displays or landscaping, and it is important that these elements do not infringe upon the Pedestrian Zone.

The Pedestrian Zone is the area of the sidewalk corridor that is specifically reserved for pedestrian travel. It should be well-lit and functional in all weather conditions. This zone must be free of any physical obstructions to allow for unfettered pedestrian movement. Street furniture, plantings, outdoor seating, surface utilities, and other elements belonging to the Frontage Zone or Greenscape/Furnishing Zone should not protrude into the Pedestrian Zone.

The quality of the surface is of the utmost importance in the Pedestrian Zone, and must meet accessibility standards referenced in these guidelines, as well as Code of Massachusetts Regulation (CMR) 521 Architectural Access Board guidelines and the Federally Proposed Accessibility Guidelines for Pedestrian Facilities in the Public Right-of-Way. The surface material should be smooth, stable, and slip resistant, with minimal gaps, rough surfaces, and vibration-causing features.

In the City of Boston bicycling on sidewalks is generally discouraged. Riding on sidewalks has significant safety implications, and can create conflicts with pedestrians as well as motor vehicles not expecting bicyclists at intersections and driveways. The City of Boston's goal is to increase bicycling, and ideally provide dedicated bicycle facilities separated from the sidewalk.

The Greenscape/Furnishing Zone is the area between the curb and the Pedestrian Zone. This zone is where street trees, stormwater elements, street lights, signage, hydrants, benches, bicycle racks, public art, trash and recycling receptacles, parking meters, transit stops, signal and lighting control boxes, and utility hatch covers should be located. As such, this zone collects the objects that may obstruct pedestrian flow, and simultaneously provides a buffer for pedestrians from the adjacent roadway. Vertical objects in the Greenscape/Furnishing Zone must be strategically placed to not obstruct sight lines, prevent damage from vehicles on the street, and to allow for access to and from parked cars.

When curbs are moved to widen sidewalks or create curb extensions, all furnishings must also be moved so they do not encroach on the newly established Pedestrian Zone.

This zone should also be designed to accommodate snow storage in the winter to prevent snow from being stored in the Pedestrian Zone. Greenscape elements should be designed to make use of stormwater runoff from the sidewalk and/or the street.

The Curb Zone is the area between the edge of the roadway and the front edge of the Greenscape/Furnishing Zone. In Boston, typically curbs are made of granite. Rolled or mountable curbs should not be used because they enable motorists to park on sidewalks. Shared Streets are curbless and flush with the roadway, while some historic streets have granite slabs that extend from the back of the sidewalk to the edge of the roadway. Although the width of the curb can vary, it should be clear of any vertical elements to allow for access from parked vehicles.

Sidewalk Zone Widths

The width of the sidewalk contributes to the degree of comfort and enjoyment of walking along a street. Narrow sidewalks do not support lively pedestrian activity, and may create dangerous conditions where people walk in the street. Typically, a five foot wide Pedestrian Zone supports two people walking side by side or two wheel chairs passing each other. An eight foot wide Pedestrian Zone allows two pairs of people to comfortably pass each other, and a ten foot or wider Pedestrian Zone can support high volumes of pedestrians.

Vibrant sidewalks bustling with pedestrian activity are not only used for transportation, but for social walking, lingering, and people watching. Sidewalks, especially along Downtown Commercial, Downtown Mixed-Use, and Neighborhood Main Streets, should encourage social uses of the sidewalk realm by providing adequate widths.

When determining sidewalk zone widths, factors to consider include the available right-of-way, anticipated pedestrian volumes, ridership projections for locations near transit, and the locations of bus shelters and transfer points.

Historically, a majority of sidewalks in Boston's neighborhoods were built to be 7' wide. Widening sidewalks by a few feet is often cost prohibitive and may require significant changes to drainage infrastructure as well as the relocation of utilities. While these guidelines prescribe more generous preferred sidewalk zone widths during street reconstruction projects, they also establish a total minimum sidewalk width of 7' for several Street Types.

If feasible to adjust curb locations, the widening of sidewalks may be achieved by narrowing and/or removing travel lanes or parking lanes, or establishing setbacks as a part of redevelopments. Where setbacks cannot be established or roadway space cannot be reallocated, consider converting the roadway to a Shared Street to increase pedestrian space and reduce vehicle speeds.

Appropriate sidewalk widths should be determined in consultation with the PWD and the Boston Transportation Department (BTD), and approved by the Public Improvement Commission (PIC).

When making decisions for how to allocate sidewalk space, the following principles should be used:

Frontage Zone

- ▶ The Frontage Zone should be maximized to provide space for cafés, plazas, and greenscape elements along building facades wherever possible, but not at the expense of reducing the Pedestrian Zone beyond the recommended minimum widths.

Pedestrian Zone

- ▶ The Pedestrian Zone should be clear of any obstructions including utilities, traffic control devices, trees, and furniture. When reconstructing sidewalks and relocating utilities, all utility access points and obstructions should be relocated outside of the Pedestrian Zone.
- ▶ While sidewalks do not need to be perfectly straight, the Pedestrian Zone should not weave back and forth in the right-of-way for no other reason than to introduce curves. Meandering sidewalks create navigational difficulties for pedestrians with vision impairments.
- ▶ In high volume, high density pedestrian areas, the Pedestrian Zone should be balanced with other Zones to accommodate large amounts of pedestrian traffic.

Greenscape/Furnishing Zone

- ▶ Maximize the Greenscape/Furnishing Zone to provide as much of a buffer as possible between the Pedestrian Zone and adjacent street traffic; however do not reduce the Pedestrian Zone beyond the minimum recommended widths. When space is limited, parked cars and bicycle lanes can also serve as a buffer between the Pedestrian Zone and moving traffic.
- ▶ For new developments and where opportunities are available to create a consistent setback, designs should accommodate wider sidewalks with generous Greenscape/Furnishing Zones.
- ▶ On roadways without on-street parking and/or higher speeds, setbacks for vertical elements should be **greater than 18"** where feasible.
- ▶ Consider traffic calming elements, such as curb extensions or chicanes where on-street parking is present, to provide more space for street furniture, trees, and other amenities.

Curb Zone

- ▶ In the City of Boston all curbs are typically made of granite and are **6" wide with a 6" vertical reveal**.
- ▶ The Curb Zone should be free from all objects, furniture, sign posts, etc.

Preferred and Minimum Widths for Sidewalk Zones

The width and design of sidewalks will vary depending on street typology, functional classification, and demand. Below are the City of Boston's preferred and minimum widths for each Sidewalk Zone by Street Type.

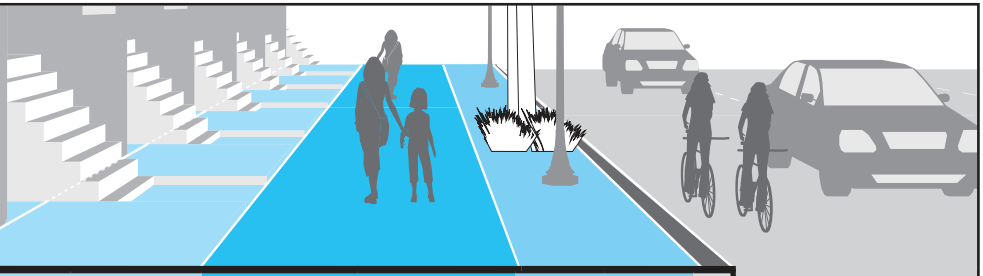

Street Type	Frontage Zone		Pedestrian Zone*		Greenscape/ Furnishing Zone		Curb Zone	Total Width	
	Preferred	Minimum	Preferred	Minimum	Preferred	Minimum		Preferred	Minimum
Downtown Commercial	2'	0'	12'	8'	6'	1'-6"	6"	20'-6"	10'
Downtown Mixed-Use	2'	0'	10'	8'	6'	1'-6"	6"	18'-6"	10'
Neighborhood Main	2'	0'	8'	5'	6'	1'-6"	6"	16'-6"	7'
Neighborhood Connector	2'	0'	8'	5' (4)*	5'	1'-6"	6"	15'-6"	7'
Neighborhood Residential	2'	0'	5'	5' (4)*	4'	1'-6"	6"	11'-6"	7'
Industrial Street	2'	0'	5'	5' (4)*	4'	1'-6"	6"	11'-6"	7'
Shared Street	2'	0'	Varies	5' (4)*	N/A	N/A	N/A	Varies	Varies
Parkway	N/A	N/A	6'	5'	10'	5'	6"	16'-6"	10'-6"
Boulevard	2'	0'	6'	5'	10'	5'	6"	18'-6"	11'-6"

Notes

* 5' is the preferred minimum width of the Pedestrian Zone in the City of Boston. The Americans with Disabilities Act (ADA) minimum 4' wide Pedestrian Zone can be applied using engineering judgement when retrofitting 7' wide existing sidewalks where widening is not feasible.

Frontage Zone

- ▶ Where buildings are located against the back of the sidewalk and constrained situations do not provide width for the Frontage Zone, the effective width of the Pedestrian Zone is reduced by 1', as pedestrians will shy from the building edge.
- ▶ The preferred width of the Frontage Zone to accommodate sidewalk cafés is 6'.

Pedestrian Zone

- ▶ Based on engineering judgment in consultation with PWD and the Mayor's Commission for Person's with Disabilities, the ADA minimum 4' Pedestrian Zone (plus 5' of width every 200') may be applied.

Greenscape/Furnishing Zone

- ▶ The minimum width of the Greenscape/Furnishing Zone necessary to support standard street tree installation is 2'-6".
- ▶ Utilities, street trees, and other sidewalk furnishings should be set back from curb face a minimum of 18".

Curb Zone

- ▶ Although the typical width of the Curb Zone is 6", widths may vary; additional width beyond 6" should be calculated as a part of the Greenscape/Furnishing Zone.



Sidewalks by Boston's Street Types

The character of sidewalks can vary widely depending upon the neighborhood context and Street Type. The four zones of the sidewalk — the Frontage, Pedestrian, Greenscape/Furnishing, and Curb Zones — assume different purposes and varying degrees of prominence in each Street Type.

Boston seeks to optimize its streets and sidewalks while respecting the historic fabric of the city. In many places, narrow streets and sidewalks are integral to a neighborhood's identity. In previous generations, buildings were often demolished to make space for wider roads and the modern highway and street network. Boston was one of the first American cities to begin the reversal of this trend, and in the early 1970s made history by converting land and funding intended for a limited access highway into a public transit corridor with bicycle and pedestrian accommodations, greenways, and open spaces.

On Street Types with higher speed roadways, the buffer between the Pedestrian Zone and the adjacent motor vehicle traffic is important in order to encourage walking; the degree of separation from motor vehicles determines comfort and safety for pedestrians. The Greenscape/Furnishing Zone, as well as parked cars and bicycle lanes, can help improve comfort and safety for pedestrians.

The following section provides a discussion of sidewalk design considerations for each of Boston's new Street Types:

- ▶ Downtown Commercial Street
- ▶ Downtown Mixed-Use Street
- ▶ Neighborhood Main Street
- ▶ Neighborhood Connector Street
- ▶ Neighborhood Residential Street
- ▶ Industrial Street
- ▶ Shared Street
- ▶ Parkway
- ▶ Boulevard

Downtown Commercial

Wide Pedestrian Zones dominate Downtown Commercial streets and accommodate high volumes of pedestrian traffic. Continuous building facades provide visual interest at ground-level, with the Frontage Zone announcing building entrances and the occasional café. The Greenscape/Furnishing Zone is characterized by planters and high-quality finishes as are prominent along Federal and Boylston Streets. Street furniture, public art, and wayfinding are featured in the Greenscape/Furnishing Zone.

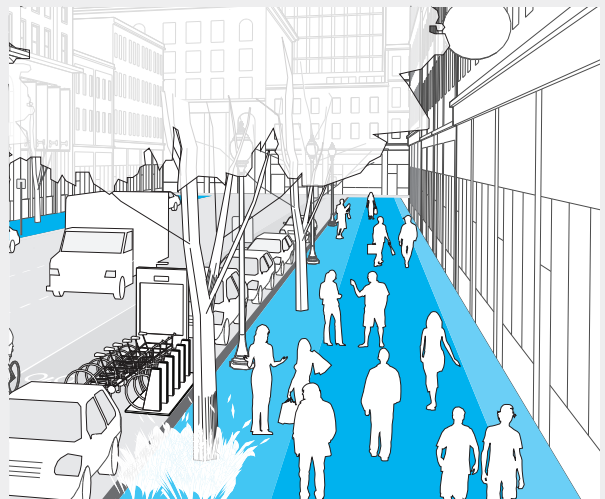

Downtown Mixed-Use

High pedestrian volumes and a wide Pedestrian Zone take center stage on Downtown Mixed-Use Streets. Use of the Frontage Zone varies based on land use, such as chairs and tables at cafés, planted areas at residential entrances, and sidewalk retail spilling out of stores. Typically the Greenscape/Furnishing Zone is narrow and functional. The layered and ever-changing Frontage Zone makes the sidewalks of Downtown Mixed-Use Streets stimulating places that encourage pedestrians to linger and interact. Newbury Street in Back Bay and Tremont Street in the South End exemplify the character of this Street Type.

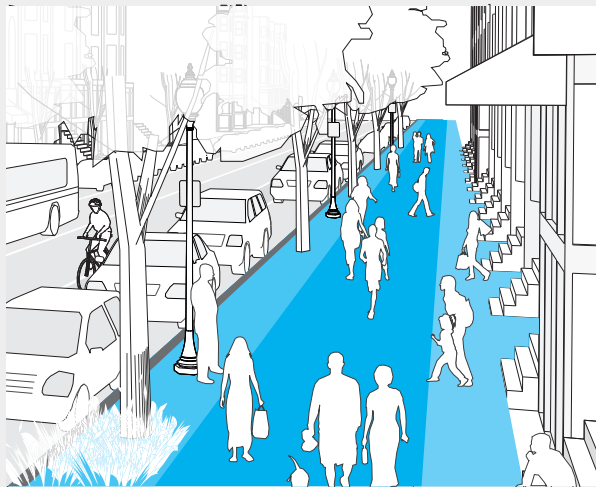

Neighborhood Main Street

Similar to Downtown Mixed-Use streets, these streets are also characterized by high volumes of pedestrian activity and a mix of uses along the sidewalk. The overall scale though is smaller than Downtown Streets, with typically narrower sidewalks such as those on Dorchester Avenue in Dorchester and along Centre and South Streets in Jamaica Plain. The focus is on providing access to the many entrances of small businesses lining the street. The Greenscape/Furnishing Zone should be as generous as possible and flexible in order to accommodate holiday events, farmers' markets, street fairs, and other community gatherings.

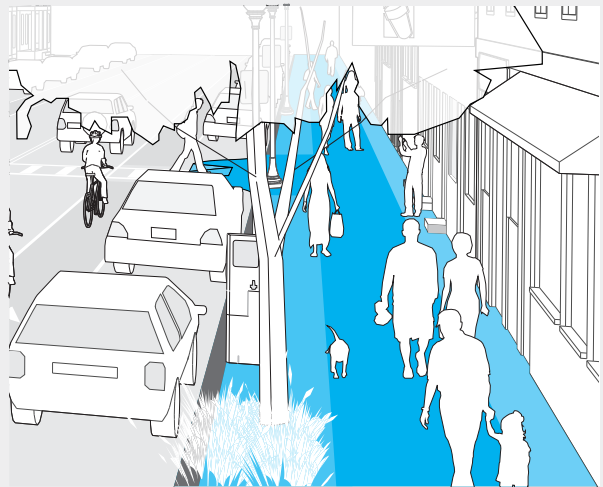

Neighborhood Connector

Neighborhood Connectors balance the needs of people passing through with those who live and work along the street. Regularly spaced trees and lighting in the Greenscape/Furnishing Zone provide unifying elements on long streets connecting neighborhoods such as Hyde Park Avenue. This type of street can have a relatively high volume of pedestrians and often includes transit routes. The Greenscape/Furnishing Zone is a critical buffer between pedestrians and high volume traffic, and can also provide opportunities for stormwater treatment and air pollution mitigation, especially with new tree plantings.

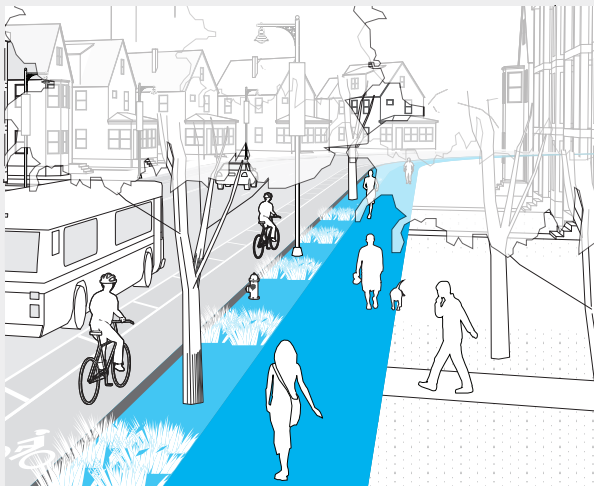

Neighborhood Residential

Neighborhood Residential Streets typically have narrow widths, slower speeds, on-street parking, and a less populated sidewalk environment. The Greenscape/Furnishing Zone can accommodate street trees, utilities, and sign posts, and a clear and unobstructed Pedestrian Zone should be provided. Stormwater practices can be small, such as green gutters, or more extensive depending on the nature of the street. Visual interest is provided by architectural detail and greenscape elements on adjacent private property.

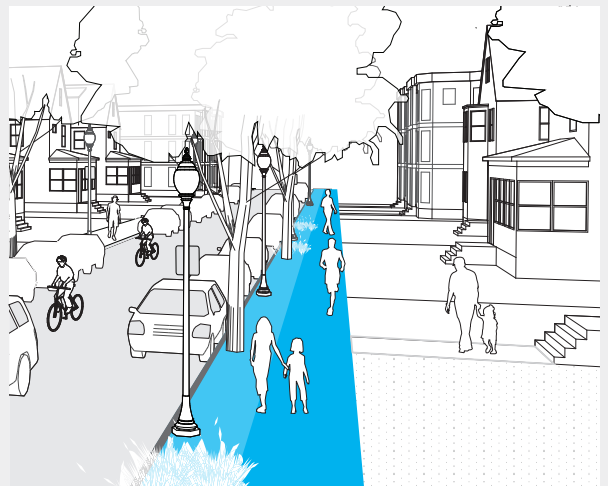

Industrial

The sidewalks in industrial districts should be utilitarian and uncluttered. Street furniture is mainly limited to street lighting and other essential elements. There may be significant opportunities to incorporate stormwater management strategies along the sidewalks. Street trees and plantings can help mitigate pollutants in the air and water via phytoremediation, as well as provide a buffer to traffic. Bollards are useful for protecting pedestrians where turning vehicles can pose a hazard. Loading docks and driveways that cross the sidewalk should be clearly delineated for pedestrian safety.

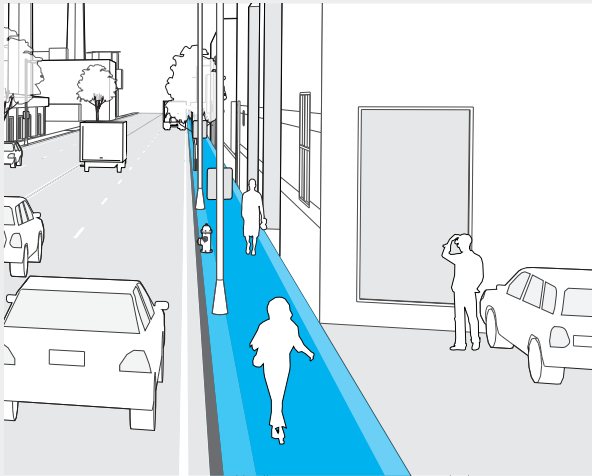

Shared Streets

Shared Streets are curbsless, and the distinction between the zones of the sidewalk, as well as the sidewalk and roadway itself, are blurred. Cross Street in the North End is a recently constructed example. Frontage Zone uses such as cafés can extend from the building face towards the middle of the street and be framed by planters and railings. The creative design of street furniture, greenscape, and lighting can help channelize, direct, and slow vehicles by creating chicanes, parking, and loading zones. While the width of the Pedestrian Zone can vary along a Shared Street, there must be a continuous accessible path along the entire length of the roadway. Bollards are often used to protect the accessible pedestrian path, and subtle changes in materials can be used to differentiate zones.

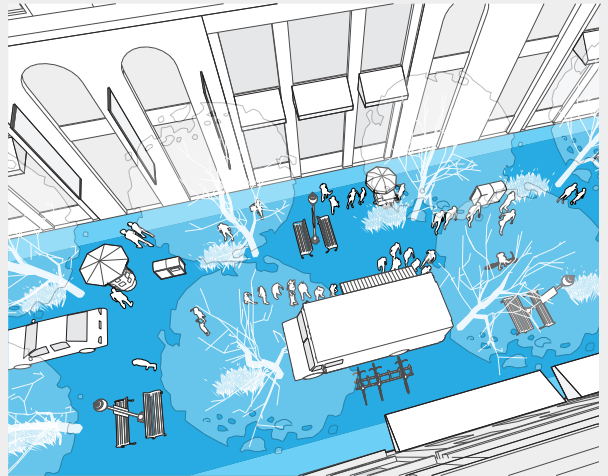

Parkways

Parkways in Boston typically run adjacent to open spaces and provide travel for bicyclists and pedestrians often on shared-use paths like those along the Emerald Necklace. A generous Greenscape/Furnishing Zone provides a buffer between the Pedestrian Zone and higher speed motor vehicle traffic, and accommodates trees and opportunities for stormwater management elements. Street furniture should generally be located within the park rather than in the Greenscape/Furnishing Zone due to higher motor vehicle speeds. On Parkways with bicycle routes or high volumes of bicyclists, designs should accommodate separate pedestrian and bicycle facilities; however, where space is constrained, designs should follow shared-use path guidelines.



Boulevards

Boulevards such as Commonwealth Avenue are similar to Parkways in scale, but are characterized by a strong building edge and continuous rows of trees. The Greenscape/Furnishing Zone is generally larger than the Pedestrian Zone to provide a buffer from higher-speed traffic. Strolling is popular on Boulevards, and the Pedestrian Zone should be wide enough to accommodate groups of people passing each other. Stormwater management systems can incorporate large trees as well as low growing vegetation. Street furniture should be formal and belong to a single style family to create a unified landscape.

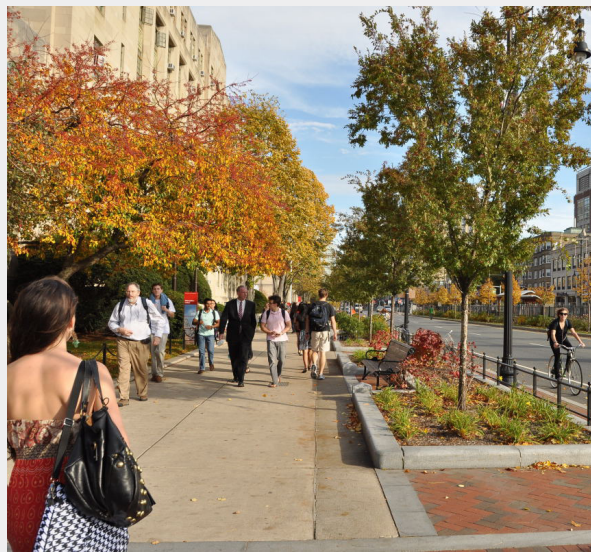
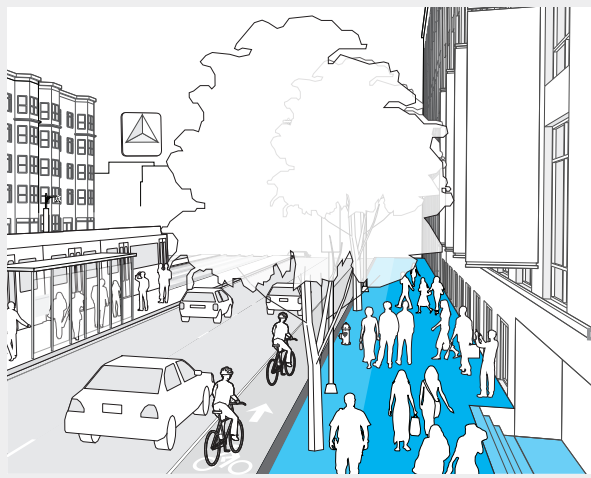



Features to Activate Sidewalks

- 32 Vibrant Street Wall
- 33 Green Walls
- 34 Plazas
- 35 Sidewalk Cafés
- 36 Driveways
- 38 Building Entrances

Sidewalks play a key role in creating a vibrant public environment; they help create a sense of place and community, provide a place to watch the world go by, and allow for face-to-face interaction. Pedestrian friendly sidewalks should be comfortable in terms of scale, temperature, and security. The sidewalk environment should be pleasing to the senses, offering visual stimulation, greenery, and a social atmosphere. Vibrant, pedestrian-friendly sidewalks attract activity and are both an indicator of, and a factor in, economic vitality.

The sidewalk and street environment (public realm) work together with building facades (private realm) to create active and vibrant edges. The relationship between the public and private realm has a significant impact on the walking experience. The quality of the materials or image the private realm presents to the sidewalk is very important, as well as how the private realm crosses the sidewalk at driveways and building entrances.

Cafés and plazas enliven the sidewalk by encouraging people to linger and socialize. As the use of cell phones and mobile computing devices continue to increase, traditional public spaces can incorporate Wi-Fi and smart technology such as informational "tags." They can also utilize feedback obtained through applications such as Citizens Connect to improve operations and efficiency, overall enhancing users' experiences. Streetscape improvement projects are good opportunities to redistribute the public right-of-way to create places for people to gather along streets.

The following sections describe features to activate sidewalks, and how sidewalks can be places in and of themselves.

Publicly owned plazas and the permitting of outdoor cafés and push cart vendors are managed by PWD and must be approved by PIC. The Boston Redevelopment Authority (BRA) should be consulted in the design of plazas and cafés; maintenance agreements with abutters are typically required.

Vibrant Street Wall

Well-designed ground-floor spaces with a mix of uses are principle ingredients for a vibrant street front, particularly on Downtown Commercial, Downtown Mixed-Use, Neighborhood Main Street, and Shared Street Types. Offices, residences, and other uses that desire privacy are best placed on floors above the street level. Retail and restaurant uses are more conducive to a vibrant street wall and are preferred on the ground floor adjacent to the sidewalk.

The modulation of building facades and treatments creates visual interest along the street wall. Large windows visible from the sidewalk expose activity within the building to the passerby, and help blend the boundary between the sidewalk environment and indoor spaces.

Awnings, lighting, signs, and foliage also contribute to visual interest, as they add color and texture to the street edge. Hanging baskets of flowers and plants on light poles and building facades provide color and seasonal variety to sidewalks. This can also be achieved with flower boxes, low planters, or vines on the building face. Awnings and signs should be scaled for both drivers and pedestrians. Awnings can provide shelter from the elements in addition to demarcating stores and entrances. Signs should be unique but made of appropriate materials reflecting the urban context of the neighborhood and Street Type.

With the exception of Parkways and Residential Street Types, permitted vending in the Frontage Zone is encouraged where sufficient space exists. Street vending can take the form of movable pushcarts or permanent stands or kiosks; tables are discouraged.

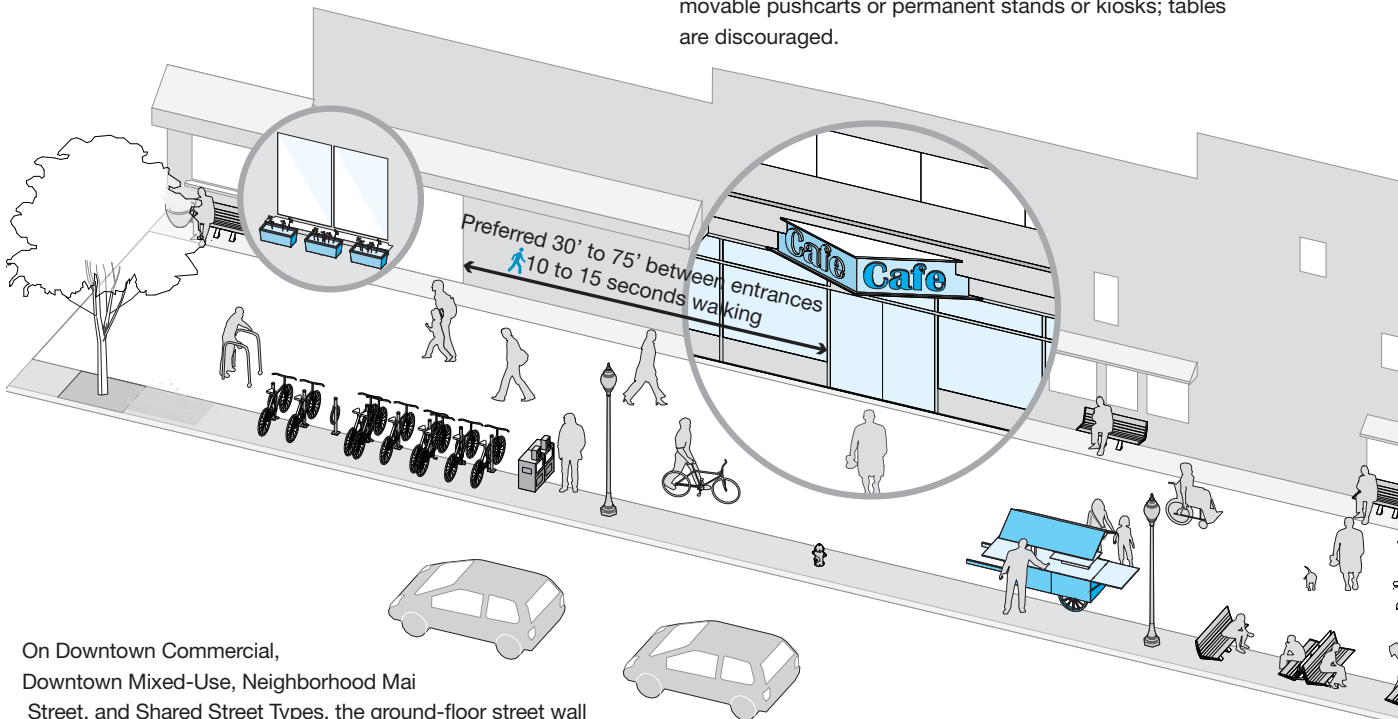

On Downtown Commercial, Downtown Mixed-Use, Neighborhood Main Street, and Shared Street Types, the ground-floor street wall should be 50% transparent. Transparency calculations do not include garage entrances, loading docks, egress doors, utility vaults, and service areas. The desired distance between ground-level pedestrian entrances in new development projects along these Street Types is between **30' and 75'**, or about one entrance every 10 to 15 seconds as a person walks along a street. Some of Boston's older streets may have building entrances every 10' to 20', such as along Charles Street in Beacon Hill.

Street performers with proper permits and without amplification can perform along Downtown Commercial, Downtown Mixed-Use and Neighborhood Main Streets. Street stands, vending, and performances must maintain a **minimum 5' wide** Pedestrian Zone, and must not create unsafe conditions that could impact pedestrians with disabilities.

All vendors must obtain a permit from PWD. Vendors with proper permits can sell food, print material, or goods and clothing.

Green Walls

Overview

Where transparency in the building edge is not achievable, greenwalls are encouraged to provide visual interest and variation to the street edge. Greenwalls can perform storm-water management functions, increase energy efficiency, and improve air quality.

Plants can be rooted in the ground and trained up the wall or in modular panels on the wall. In addition to making building surfaces more attractive, greenwalls can reduce the “heat island effect,” provide thermal insulation for buildings. Most greenwalls use irrigation systems to water plants throughout the year, and come in different forms, shapes, costs, and functions.

The installation and maintenance of greenwalls is the responsibility of the building owner. If plantings encroach into the public right-of-way, greenwalls require approval by PIC.

Green walls provide attractive and environmentally friendly building surfaces that help reduce energy costs, reduce stormwater runoff, and improve air quality.

Use

Modular panels come in three basic varieties of growing mediums. They are composed of loose soil, fiber or felt mats, or structural mediums which combine the two. The appropriate type of system depends on the building structure and availability of water.

- ▶ Structural mediums are preferred despite higher installation costs. These systems are long-lasting, require less maintenance, and are more flexible.
- ▶ Loose-soil systems are best suited where occasional replanting and regular maintenance is possible. Loose soil can be messy, may erode over time, and is not suitable for tall structures.
- ▶ Mat mediums are appropriate for applications where the structure cannot support heavy loads. Mat mediums tend to be thin, do not retain water well, do not support robust root systems, and are not suitable for tall structures.

Considerations

- ▶ Applications that require irrigation systems must be monitored and shut off so pipes do not freeze in winter.

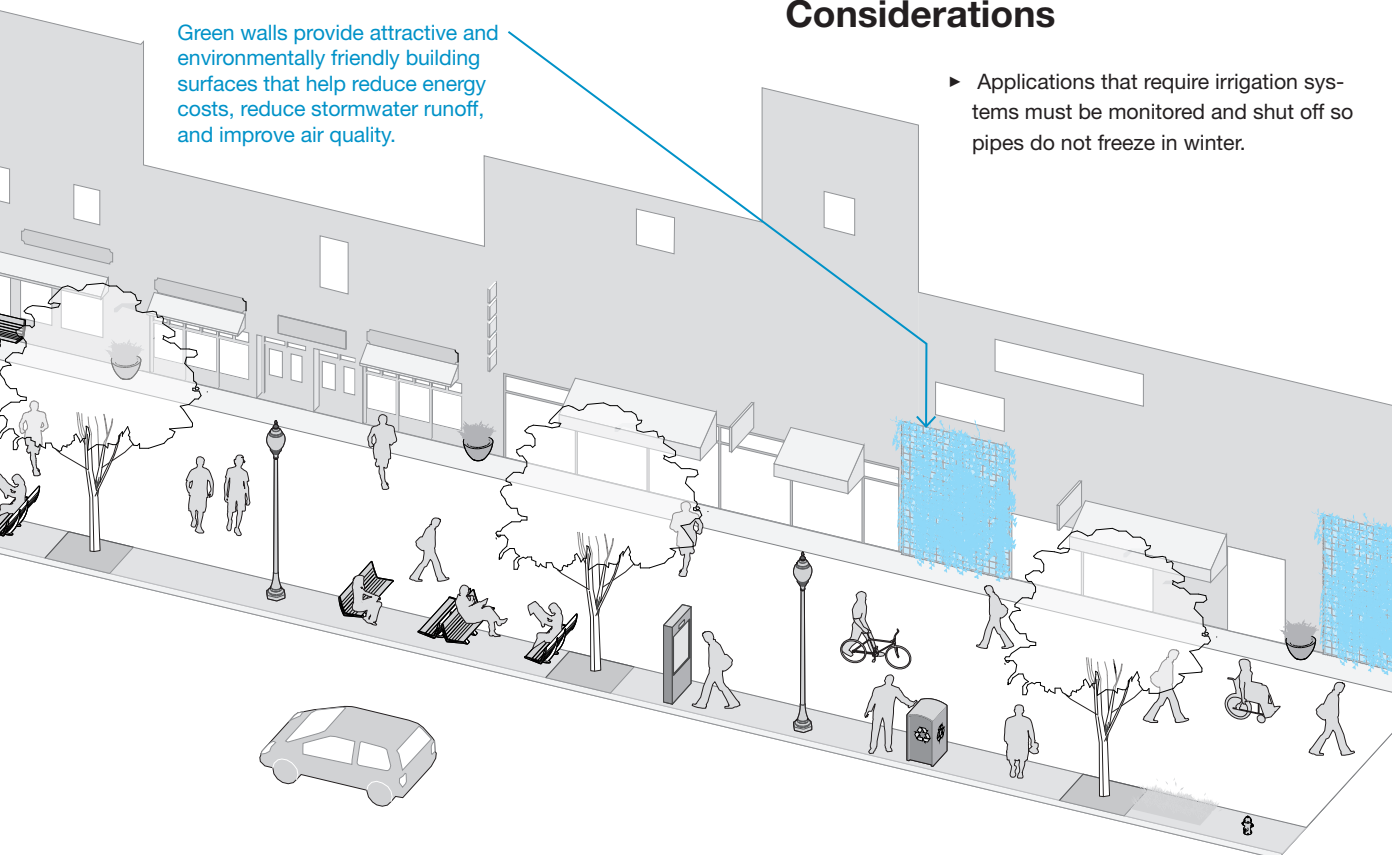

Plazas

Overview

A plaza is a pedestrian space in the public realm built for enjoyment, lingering, and as a gathering place for special events. Plazas are encouraged as a part of all streetscape designs to create a sense of place and enliven sidewalks. Successful plazas attract people through the presence of others, and support a wide variety of activities including temporary markets, art installations, and/or performances. Plazas are also opportunities to incorporate the green and smart principles of these guidelines.

The Boston PWD is responsible for the management of publicly owned plazas. BTD and BRA must be consulted in the design of plazas and they must be approved by PIC; maintenance agreements with abutters are typically required.

Use

Plazas can be created as a part of private developments or through the reclamation of space in the public right-of-way. They should be located adjacent to transit or other pedestrian generators wherever possible. Transitions between sidewalks and plazas should be as broad and seamless as possible to invite people to the space. Accessible routes must be maintained from the sidewalk and through the plaza to building entrances and transit stops.

Plazas are excellent places to incorporate stormwater management elements. They should be as sustainable as possible and easy to maintain as they will require maintenance agreements.

Plazas should provide a variety of seating options, some of which may be movable. Seating can be incorporated into building edges, walls, and landscaping containers. Typically, dedicate at least 10% of a plaza's open-space to seating. Movable chairs provide ultimate flexibility for a public space and allow for variation in arrangements to suit personal preference, to capture sun or shade, or to sit in a group or alone.

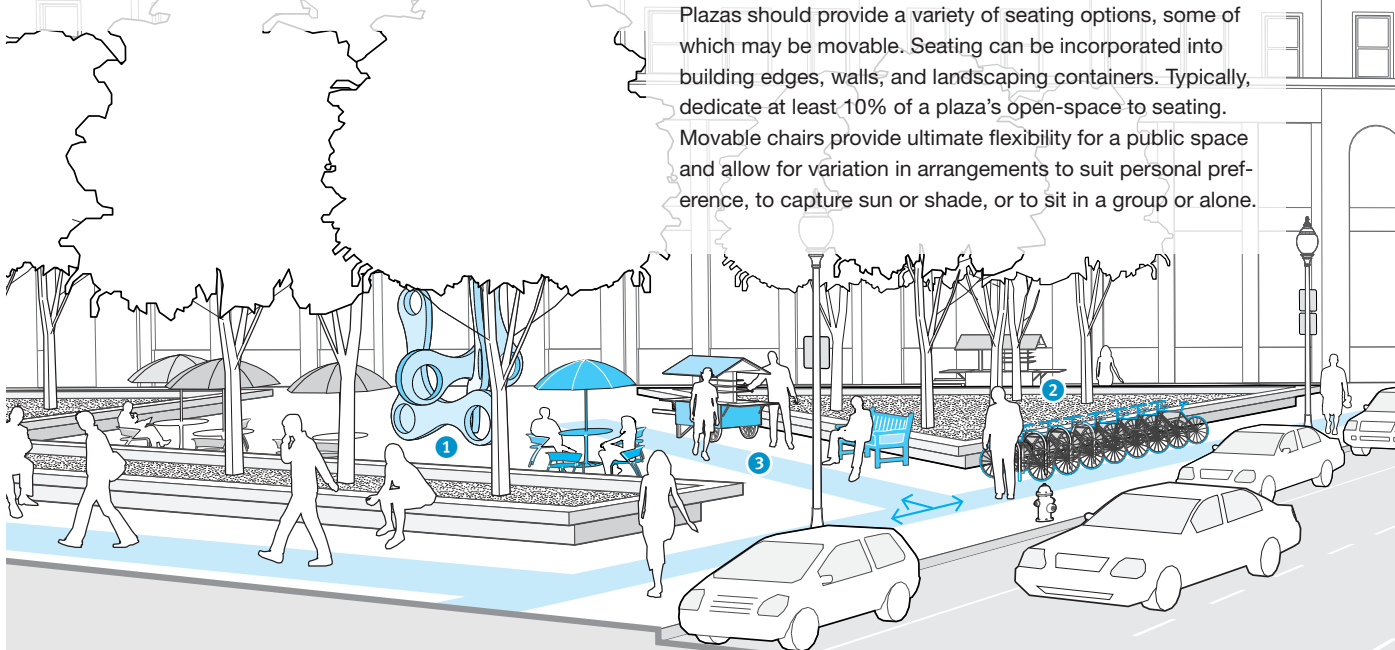

Considerations

- ▶ Consider using permeable, recycled, and/or locally sourced materials to maximize sustainability. Subsurface recharge or storage for stormwater should also be considered.
- ▶ Designs should incorporate built or digital wayfinding, information installations, and temporary or permanent public art displays ①. When possible, plazas should provide public Wi-Fi.
- ▶ Space in plazas should be considered for bicycle parking ②.
- ▶ Adjacent businesses can provide food or services to make a plaza more inviting, as well as share responsibility as caretakers of the space.
- ▶ Designs should consider how the plaza will be used. Consider providing assembly areas for people to gather for performances and special events. Locations for mobile vending carts and stalls should consider the needs for power or water, and must maintain a clear pedestrian path ③.

Sidewalk Cafés

Overview

Sidewalk cafés are encouraged on all Street Types where commercial activity occurs, including industrial areas. The extension of restaurant businesses into the public way brings activity and energy to the public realm. The renting of this space by private businesses can also result in a higher level of maintenance and cleanliness. Careful attention must be given to the design and layout of sidewalk cafés to maintain sidewalk functionality and the quality of the public environment.

The following guidelines expand upon existing regulations and the Greenway Café Guidelines while focusing specifically on the impact of sidewalk cafés on the pedestrian environment.

PWD is responsible for the permitting of outdoor cafés. BTD and BRA must be consulted in the design of cafés and be approved by PIC; maintenance agreements with abutters are typically required.

Use

- ▶ Typically, the preferred **minimum width of a sidewalk café is 6' deep**, which must be contiguous with the dining establishment (not across a public way). Cafés may not extend beyond the limits of the establishment into neighboring businesses. A **minimum 4'** clear path should be maintained to the front door of the dining establishment.
- ▶ A clear accessible pedestrian path of must be maintained on the sidewalk. Consider providing additional Pedestrian Zone width in areas with higher pedestrian volumes. Planters and other greenscape/furnishing elements must not protrude into the Pedestrian Zone.
- ▶ All sidewalk cafés are encouraged to provide an enclosure dividing the café from the public right-of-way. If alcohol is served, an enclosure is required. Barriers must be attached to the ground but can be made of fence, rope, chains, or containment for live plants. Permanent anchors may be installed as long as the barrier is removable and the anchor is flush with the ground and ADA compliant. Enclosures must be removed after the café season has ended.
- ▶ Furniture should be durable, free-standing, and matching. Plastic furniture is discouraged.
- ▶ Awnings and/or umbrellas are desirable. Heat lamps, either free-standing or affixed to the underside of awnings, can extend outdoor dining into the colder months.

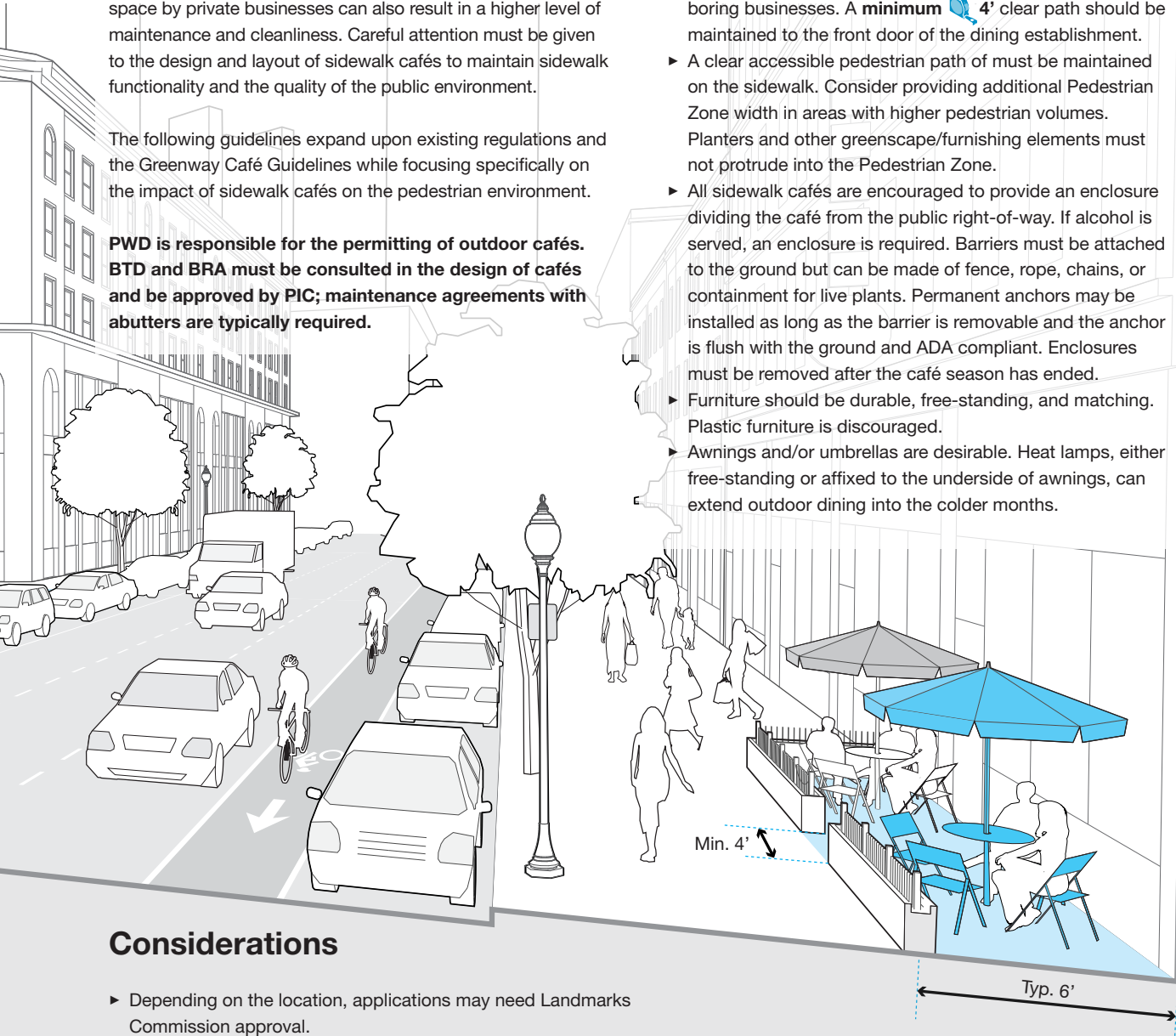

Considerations

- ▶ Depending on the location, applications may need Landmarks Commission approval.
- ▶ Cafés located on the street side of the sidewalk or in parklets must be open to the public and cannot be claimed by individual businesses.

Driveways

Overview

The design of driveways should provide a continuous and level Pedestrian Zone across the vehicular path and encourage vehicles to yield to pedestrians on the sidewalk. Driveways across public sidewalks are sometimes needed to link streets to off-street parking facilities and loading zones, however driveways can create conflicts and require special treatments in order to maintain a safe and comfortable walking environment.

New driveways, or changes to existing driveways for either commercial or residential use must be reviewed by BTM and PWD and approved by PIC.

Driveway Setbacks and Widths

	Min. Distance from Signalized Intersection	Min. Distance from Unsignalized Intersection	Min. Driveway Width	Max Driveway Width
Commercial Driveways	100'	100'	20'	24'
Residential Driveways	40'	20'	10'	12'

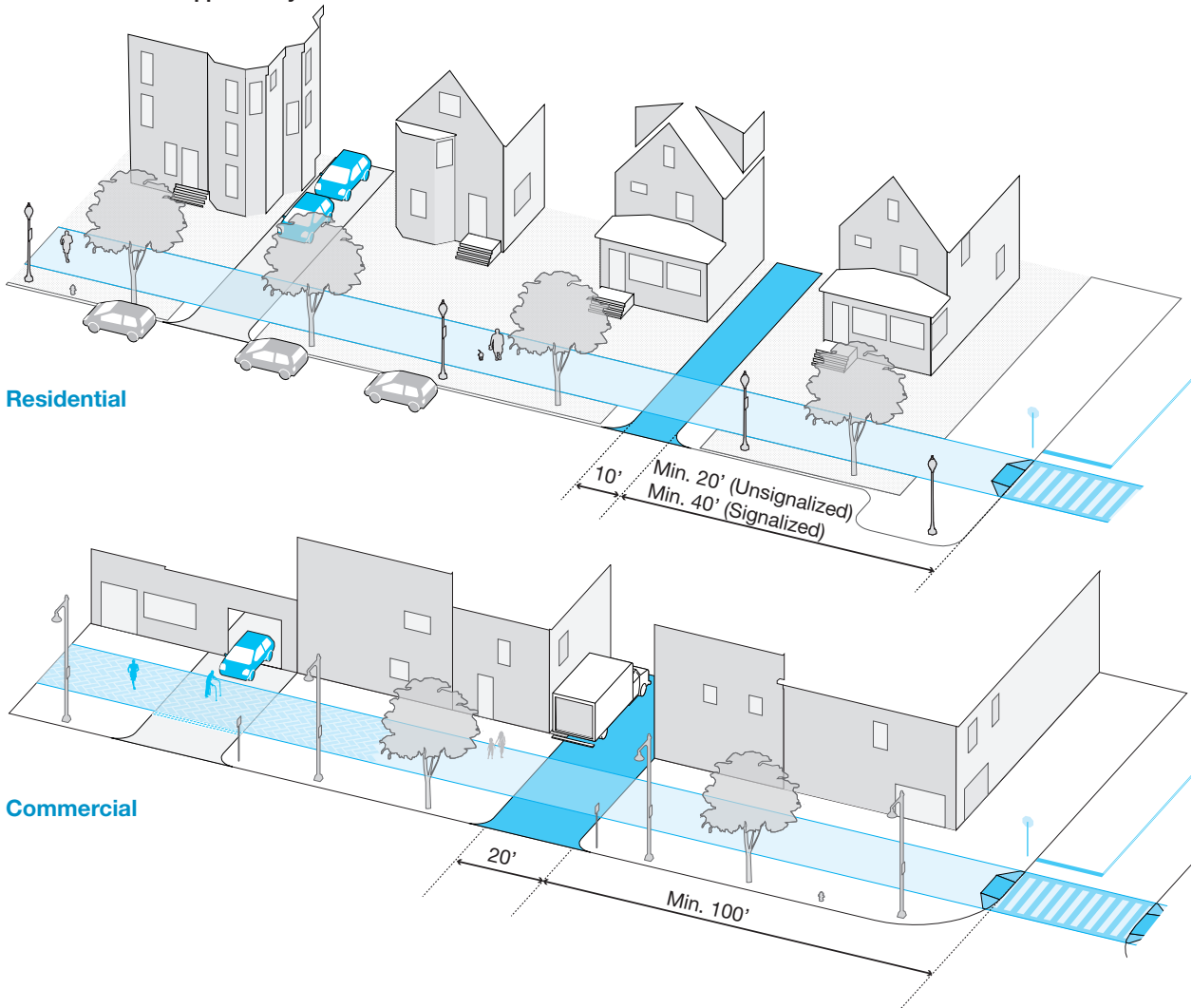

Use

The public sidewalk has the right of way over private crossings. The following general design guidelines should be followed to minimize disruption to pedestrians while ensuring safe operation:

- ▶ The Pedestrian Zone should be continuous, level, and clearly delineated across driveways to encourage drivers to yield to pedestrians (e.g., if the sidewalk is composed of concrete, the concrete surface treatment should be continuous across the driveway).
- ▶ Residential driveways should be designed with standard curb cuts and an apron outside of the Pedestrian Zone.
- ▶ Vehicular access across sidewalks must maintain the **minimum Pedestrian Zone width of 5'** and materials must meet accessibility requirements outlined in the Sidewalk Materials section found later in this chapter.

Considerations

- ▶ On Downtown Commercial, Downtown Mixed-Use, and Neighborhood Main Street Types where space permits, driveways should be designed with aprons, and maintain fully raised continuous Pedestrian Zone paths (i.e. sidewalks remain at the same height and are not lowered or partially lowered to meet the road or driveway).
- ▶ In constrained locations where the width of the sidewalk is insufficient for a fully raised crossing, the roadway can be partially raised and the sidewalk partially lowered. This design minimizes the disruption to the pedestrian while still providing a traffic calming effect. On a **typical 6" high** sidewalk, this is achieved by ramping down the sidewalk at the driveway by **3"** and raising the driveway by the same amount **1**.
- ▶ If the sidewalk is too narrow to meet the minimum width requirements in the Pedestrian Zone, a curb extension should be considered where on-street parking is present. In locations where a driveway functions as an intersection, it should be designed with pedestrian safety features such as crosswalks, small corner radii, and pedestrian signal heads if signalized.
- ▶ Additional details for driveway design are provided in Driveway Guidelines by the BTD for use by the Boston Zoning Board of Appeal, found on the City of Boston's website.

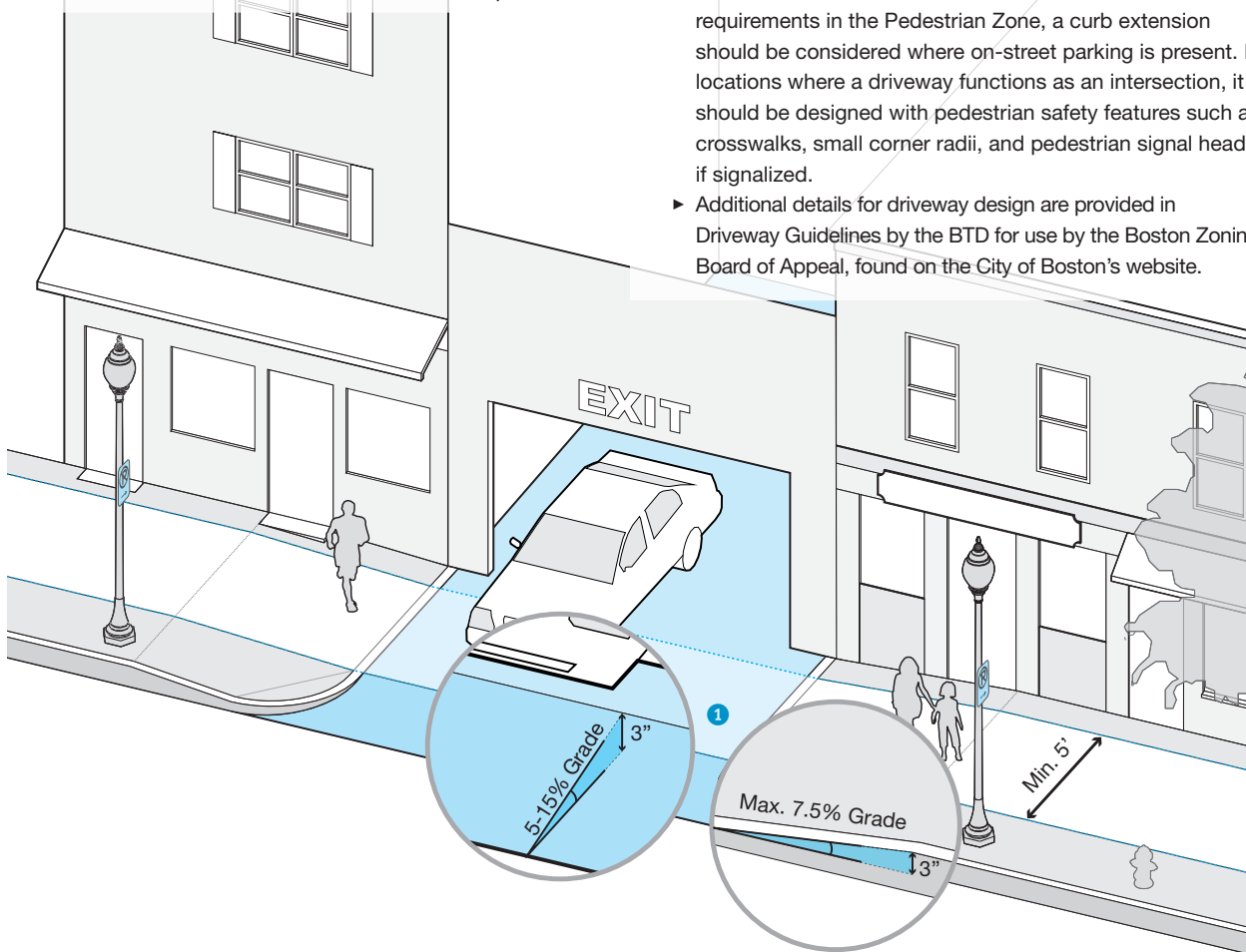

Building Entrances

Overview

Building entrances connect the indoors with the public realm and provide the public face of the building occupant. They should be convenient and welcoming to pedestrians, well maintained, and provide a good first impression. As building edges frame the street, the cooperation of building owners is critical to the success of any vibrant, livable community. Public improvement initiatives and neighborhood design guidelines can encourage investment in entrances by building owners.

Use

The design of individual entrances is especially important on Downtown Commercial, Downtown Mixed-Use, Shared, and Neighborhood Main Street Types, each of which require a strong edge and plenty of visual interest. Entrances for buildings on Neighborhood Residential and Neighborhood Connector Street Types may be set back from the sidewalk where appropriate, but should face the street and maintain a consistent street wall without large gaps between entryways.



Considerations

The design of building entrances should include the following characteristics:

- ▶ In general, buildings should front the sidewalk, and entrances should face the street, providing access to and from the sidewalk.
- ▶ The structure surrounding building entrances should be limited to the Frontage Zone to minimize impact on the Pedestrian Zone. Awnings may overhang into the Pedestrian Zone.
- ▶ Individual building entries may be accented with the use of texture or material changes in the pavement directly in front of the points of entry. Such pavement accents can also include building names, numbers, or historic information.
- ▶ Large folding or retractable doorways provide the greatest connection between the public realm and building interiors. Air doors and other industrial technologies can be applied to storefronts for increased transparency and accessibility.

Buildings with raised first floors require a transition to meet the sidewalk. Exterior transitions, including stairways, railings, and ramps, must not extend beyond the Frontage Zone ¹. Access that is integrated into the interior of the building is generally preferable but not always feasible. Interior ramps or lifts can occupy valuable retail space or crowd circulation within lobbies.

Work in Historic Districts must be reviewed and approved by the appropriate Historic District Commission.

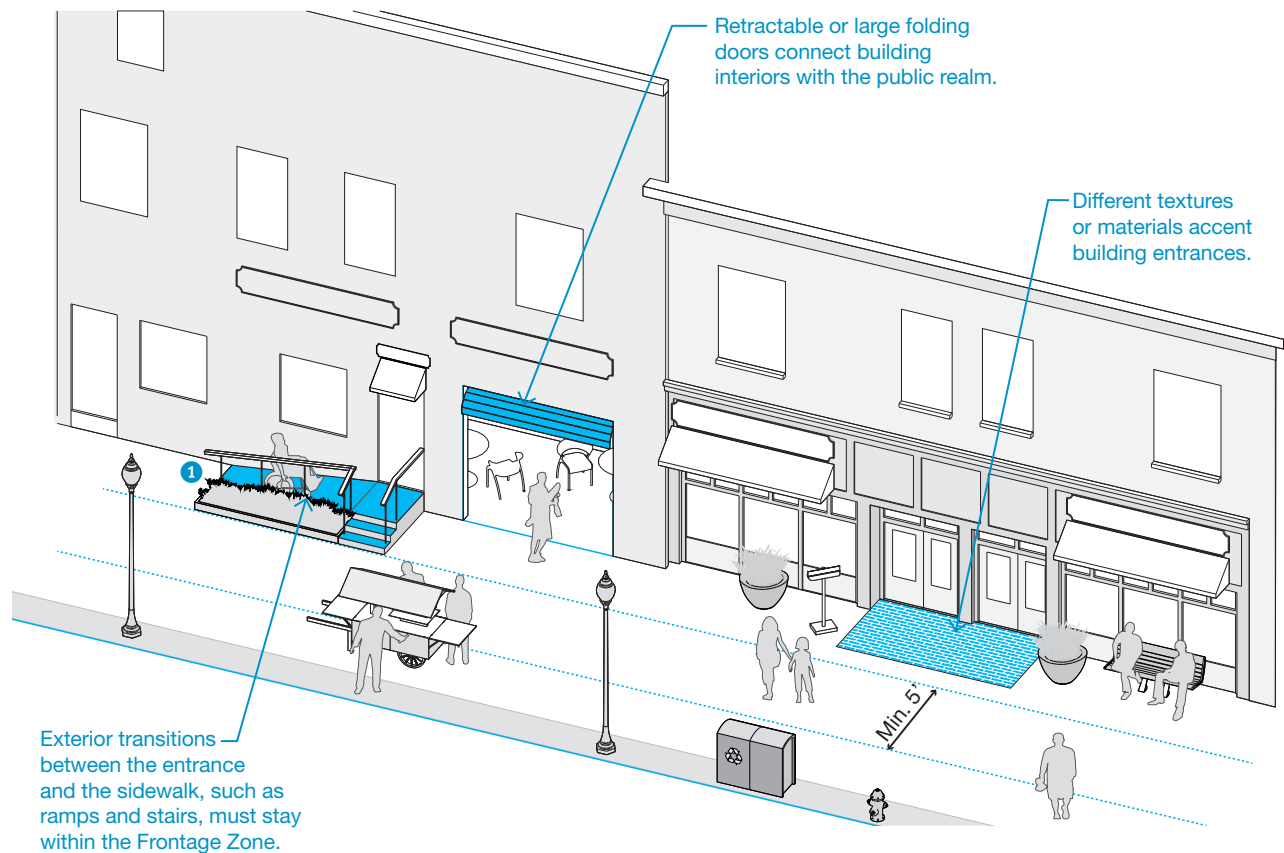



Sidewalk Materials

42 Materials and Sidewalk Zones

44 Permeable Paving Materials

The key components of sidewalk construction are proper material selection, good detailing, and quality installation; these components work together to create smooth, stable, slip resistant, and durable sidewalks.

Sidewalk design plays a major role in establishing and reinforcing neighborhood and city identity. A specific palette of materials, colors, and patterns can be used to identify a neighborhood or district. In general, Neighborhood Residential and Industrial Street Types with relatively narrow sidewalks should have a single material for the entire sidewalk. Downtown Commercial and Neighborhood Connector Street Types with wider sidewalks may have more than one type of paving material to differentiate between sidewalk zones. Varying sidewalk materials within a single zone can be used to accent or embellish special areas such as building entrances, trail approaches before crossing roadways, plaza edges, or transit stops. Inserting the name of each cross street in the paving at corners is a functional wayfinding technique. New or reconstructed sidewalks should always match those of existing sidewalks to create a continuous walking and visual experience.

Boston's sidewalks must be accessible to people of all ages and abilities. This includes everyone from people with vision, hearing, or mobility impairments to those pushing strollers or shopping carts. Accessibility is most critical in the Pedestrian Zone and at crossings. Materials and details should be selected to minimize gaps, discontinuities, rough surfaces or any other vibration causing features. Details should be designed to prevent the creation of tripping hazards as materials settle and age and to avoid uncomfortable or painful bumps and vibrations for pedestrians using wheeled devices such as walkers, strollers, and wheelchairs.

The following sections provide guidance for creating comfortable sidewalks that also have environmental benefits and reinforce a sense of place in Boston's neighborhoods.

PWD is responsible for the management of publicly-owned sidewalks. All sidewalk designs must be approved by PWD in coordination with the Mayor's Commission for Persons with Disabilities. Maintenance agreements with abutters are required for non-standard materials or installation details.

Materials and Accessibility

The City of Boston follows high accessibility standards. With respect to the public realm, the City of Boston follows accessibility requirements set by CMR 521 and the proposed Accessibility Guidelines for Pedestrian Facilities in the Public Right-of-Way (PROWAG). Refer to these guidelines for complete accessibility requirements and criteria.

Listed below are highlights of the above accessibility guidelines, which discuss design features that have the greatest impact on accessibility including the grade and cross-slope of the sidewalk, curb ramps and crossings, and the selection of materials. The guidelines below meet or exceed all Federal and local guidelines and regulations regarding accessibility:

- ▶ Surfaces should be smooth, stable, and slip resistant and should minimize gaps, rough surfaces, and vibration causing features. Discontinuities in the surface, such as gaps, rises, and falls should not exceed 1/8" where feasible.
- ▶ The cross-slope of the walking zone may not exceed 2%; 1.5% is the desired design specification.
- ▶ Ramps must be present at all intersections (excluding raised crosswalks.) Their design should minimize conflicts with motor vehicles. Detectable warnings must be included in the ramps or approaching raised crosswalks to indicate where the roadway begins. Please refer to Chapter 4: Intersections for detailed intersection and crossing guidelines.
- ▶ Design of sidewalks should avoid pooling of rainwater or ice melt. Even small amounts of water can be hazardous and form ice.
- ▶ Designs should avoid conflicts with common obstacles in the Pedestrian Zone. Street furniture, traffic control devices, retail displays, and stormwater management features must be located outside of the Pedestrian Zone. Tripping hazards such as settled or uneven sidewalk materials, abandoned sign posts, and low planters should be addressed during redesign and construction of sidewalks.
- ▶ The Pedestrian Zone should be continuous across driveways and meet all of the guidelines above. Please refer to Driveways found earlier in this chapter.

Note: This section focuses on materials for the Pedestrian Zone.

Materials and Sidewalk Zones

Overview

The primary goals for materials selection should be to maximize accessibility, sustainability, durability, drainage, and aesthetic appropriateness. Given that certain materials are better suited for specific zones and specific Street Types, designs should always be context-sensitive and reflect the character of the street. Proper subgrade preparation is critical to prevent settling and deterioration over time.

To ensure durability and limit maintenance, all material specifications must be approved by the PWD in consultation with the Mayor's Commission for Persons with Disabilities prior to installation. Treatments within the standard category may be maintained by the PWD. Materials in the enhanced category will require a maintenance agreement between abutters and the City. In general, all non-standard materials require a maintenance agreement. Treatments in the pilot category are experimental and must be done in consultation with PWD and the Mayor's Commission for Persons with Disabilities, and evaluated at regular intervals as they age. Treatments in the historic category are governed by guidelines of the appropriate Historic District Commission.

Preferred Materials for Sidewalk Zones

	Standard	Enhanced	Pilot	Historic
Curb Zone	Granite			Granite pavers
Greenscape/ Furnishing Zone	Concrete	Permeable unit pavers (See next page) Unit pavers (bricks, granite and exposed aggregate concrete) Soft paving (grass, mulch, decomposed granite)	Permeable unit pavers (See next page)	Brick accent strips (Consult with Historic District Commission)
Pedestrian Zone	Smooth finish cast-in-place concrete panels with saw cut joints (preferred) or tooled joints less than 3/8" wide	Dark aggregate and/or exposed fine aggregate concrete Unit pavers (asphalt, granite, and wire-cut brick)	Rubber Permeable pavements (See next page)	Wire-cut brick pavers Granite pavers Bluestone
Frontage Zone	When part of the Pedestrian Zone, follow Pedestrian Zone guidelines; otherwise, base materials selection on the Greenscape/Furnishing Zone guidelines.			

*Notes

Different types of materials come in an array of textures. Any paving material found in an active pedestrian path must be smooth, stable, and slip resistant, and minimize gaps, discontinuities, and vibrations.

As technology progresses, pavements should be reevaluated for appropriate use in different sidewalk zones.

Use

The following guidelines cover the selection of materials by sidewalk zone:

Curb Zone

- ▶ Granite is the standard material for curbs on city-owned streets.
- ▶ Non-standard materials may be used but require maintenance agreements.

Greenscape/Furnishing Zone

- ▶ Decorative accent strips of unit pavers are most appropriate for the Greenscape/Furnishing Zone. Accent materials can include wire-cut bricks, unit pavers, or grating. Thematic elements such as markers and plaques can be embedded in this zone.
- ▶ Pavers are not recommended where gaps will result from cutting to meet existing surface features.
- ▶ The use of stamped concrete as a substitute for brick pavers will be considered on a case-by-case basis. In all cases, the color and stamping pattern should closely match any existing brick.
- ▶ Where curbside bus stops are present, a **minimum of 5' wide by 8' deep** concrete landing zone should be provided at all bus stop doors.

Pedestrian Zone

- ▶ Concrete is the standard material for the Pedestrian Zone. Concrete panels should have a smooth, slip resistant finish as opposed to a broom finish. Concrete panels should be four square feet or larger. Panels may be as small as two square feet in limited areas such as at building entrances and driveways. "Window pane" details should be avoided.
- ▶ Concrete joints should be installed to create a surface that is as smooth and comfortable as possible to accommodate people with disabilities. Where feasible, saw cut rather than tooled joints are preferred. Installation methods must be monitored carefully as concrete can crack while curing before joints are cut. Expansion joints should be filled to reduce gaps to the maximum extent feasible to meet accessibility requirements.
- ▶ Patterns can be sandblasted into standard concrete or aggregates to change the surface.
- ▶ The selection of recycled aggregates includes recycled concrete, recycled glass, and industrial by products.
- ▶ Concrete or granite joints in the sidewalk should be oriented along the direction of travel where possible to reduce the frequency of joints across the Pedestrian Zone.
- ▶ Unit pavers may be used so long that it is feasible to achieve and maintain all accessibility requirements. Larger unit pavers are preferred to minimize joints and should be oriented in the direction of travel. Beveled-edge pavers should be avoided in the Pedestrian Zone.
- ▶ Transitions between concrete panels, unit pavers, and tree grates should be given special attention and designed to minimize bumps and differential settlement.
- ▶ Tree grate surfaces are not considered to be part of an accessible Pedestrian Zone.

Frontage Zone

- ▶ When the Frontage Zone supports active pedestrian use, like at building entrances, plazas, cafés, and where seating is provided along building facades, the Frontage Zone should be designed with the same principles as the Pedestrian Zone.
- ▶ Alternatively, when the Frontage Zone does not support active pedestrian use, such as where street trees, flower beds, rain gardens, and other greenscape elements are planted along building facades, materials selection should be similar to that of the Greenscape/Furnishing Zone.

Considerations

- ▶ The installation of traditional brick pavers may result in uneven surfaces after settling if not properly maintained; this can result in uncomfortable surfaces for those with wheel chairs, pushing strollers, or pulling suitcases.
- ▶ Concrete is the preferred material for the Pedestrian Zone; however, existing brick sidewalks may be replaced with wire-cut brick so long that all accessibility requirements are met.
- ▶ Use of unit pavers in the Pedestrian Zone requires increased oversight of installation and long-term inspection and maintenance.
- ▶ Where practical, hand-holes, vaults, tree grates, and other utility access points should be located outside of the Pedestrian Zone. Where this is not practical, these access points should match the level of the sidewalk and be firm, stable, and slip and shock resistant.
- ▶ As technology progresses, new materials should be piloted and tested so long that all accessibility requirements are met.

Existing granite slab and bluestone sidewalks are protected historic resources often found on Downtown Commercial Street Types. The guidelines below should be followed when working with historic materials:

- ▶ For new projects or major reconstruction, historic materials should be modified as necessary to be made accessible. This may involve resetting the material to make it level, treating the surface to create a non-slip texture, or shaping the material to create accessible ramps.
- ▶ Repair and reconstruction of existing brick sidewalks, though not protected historic resources, should include grading as necessary and repaving with wire-cut bricks.
- ▶ Stamped brick (i.e. concrete stamped as brick) is generally not allowed in designated Historic Districts where brick is the standard surface treatment. Stamped brick creates an uneven surface and the coloring can fade over time.

Permeable Paving Materials

Overview

Permeable paving materials allow stormwater runoff to infiltrate through the material into the ground instead of being diverted as runoff into the storm drain system. Water that permeates through the material is stored underground for gradual absorption into the soil or is filtered through the soil into the groundwater or a nearby surface water body. Permeable pavement systems can filter pollutants; reduce flooding, ponding, and ice; improve water quality; and potentially reduce the size of infrastructure needed to convey stormwater off site.

All permeable materials are considered enhanced or pilot treatments, and require maintenance agreements with the City of Boston. Construction and maintenance of all materials must be coordinated with the PWD, Boston Water and Sewer Commission (BWSC), Parks Department, and the Mayor's Commission for Persons with Disabilities.

Permeable pavements are typically under laid with an infiltration bed and subgrade soil. Permeable materials come in a number of varieties and include:

- ▶ Soft paving such as grass, mulch, and decomposed granite
- ▶ Porous unit pavers with open joints or interlocking designs, the openings are filled with porous aggregate
- ▶ Permeable concrete is concrete designed to have more void spaces that allow air and water to pass through the material
- ▶ Concrete or plastic grid systems filled with soil and grass or gravel
- ▶ Bound resin with aggregates (pervious asphalt) or bound recycled material such as glass, rubber, and plastic



Preferred Permeable Materials for Sidewalk Zones

	Standard	Enhanced	Pilot
Curb Zone	Not applicable	Not applicable	Not applicable
Greenscape/ Furnishing Zone	Not applicable	Soft paving (grass, mulch, and decomposed granite) Porous unit pavers	Permeable concrete Plastic or concrete reinforcing grids Bound recycled materials
Pedestrian Zone	Not applicable	Not applicable	Permeable Concrete Bound recycled materials
Frontage Zone	When part of the Pedestrian Zone, follow Pedestrian Zone guidelines; otherwise base materials selection on the Greenscape/Furnishing Zone guidelines.		

*Notes

Different types of materials come in an array of textures. Any paving material found in an active pedestrian path must be smooth, stable, and slip resistant, and minimize gaps, discontinuities, and vibrations.

As technology progresses permeable pavements should be reevaluated for appropriate use in different sidewalk zones.

Use

- ▶ Permeable paving can be used in a broad variety of settings. All designs must consider the drainage characteristics of the underlying soils, the depth of the water table, and the slope of adjacent land.
- ▶ Permeable pavements can be used in sidewalks, plazas, cafés, parking areas, alleys, and other low-traffic areas.
- ▶ Soft paving materials are only appropriate for the Greenscape/Furnishing Zone or Frontage Zone, typically around trees, planters, and enclosed greenscape elements.
- ▶ Permeable concrete pavement can be piloted for use in the Pedestrian Zone as long as the resulting surface is durable, smooth, stable, slip resistant, and meets all other accessibility guidelines.
- ▶ Porous unit pavers are most appropriate in the Greenscape/Furnishing Zone or the Frontage Zone, except where there is active pedestrian use such as at bus stops or at crossings. They may also be used in small plazas offset from the sidewalk Pedestrian Zone.
- ▶ In specific locations where infiltration is not desired, such as adjacent to building foundations, engineered geotextile liners can be used to redirect the water to an appropriate location.

Considerations

- ▶ Compared to traditional impermeable pavements, permeable pavements can provide increased traction when wet because water tends not to pool, and the need for salt, sand, and plowing can be reduced during winter due to low or no black ice development.
- ▶ Designs should include methods to convey larger storms to the storm drain system
- ▶ Long-term maintenance costs may be reduced because permeable pavements resist cracking and buckling in freeze-thaw conditions.
- ▶ Regular maintenance of permeable pavements include:
 - ▶ Annual inspection of unit pavers and permeable concrete for deterioration
 - ▶ Periodic replacement of sand, gravel, and vegetation where applicable
 - ▶ Annual vacuuming of pavements may be required to unclog sand and debris (Note: The use of sand in ice prevention should be avoided because it will clog pavement pores.)

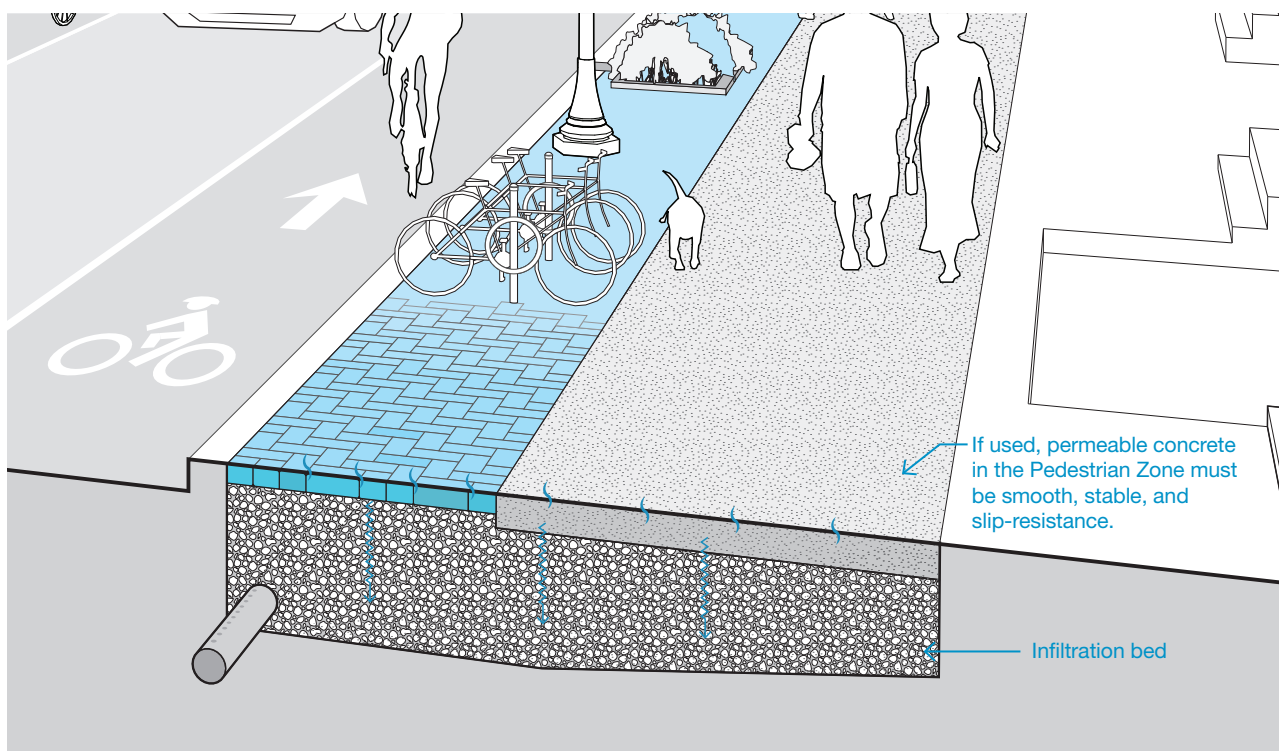

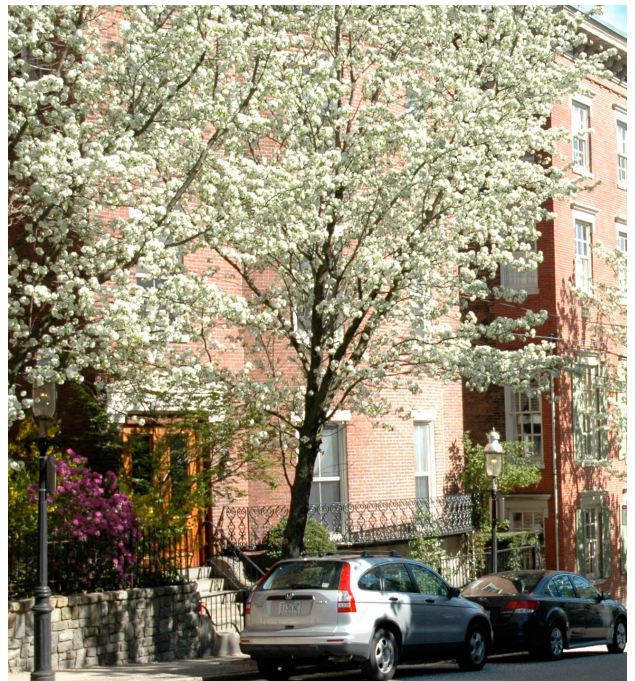

Greenscape

- 48 **Benefits of Street Trees**
- 50 **Benefits of Vegetated Stormwater Management**
- 52 **Soils Selection and Management**

Trees, shrubs, grasses, and other landscape plantings, or “greenscape,” play an important role in making streets comfortable, delightful, memorable, and sustainable. Used appropriately, they can help define the character of a street or plaza, provide shade and cooling, reduce energy consumption, and absorb and cleanse stormwater. They also absorb greenhouse gases and help filter airborne pollutants. In proximity to other green spaces, street trees can contribute to native wildlife systems.

In addition to providing environmental benefits, a healthy greenscape provides psychological and social benefits. People are attracted to places that have well-maintained plantings. Healthy green spaces are good for city life and for business. The changing light and color along a tree-lined street reminds us of the changing seasons. By connecting us with nature in its beauty and complexity, plants help reduce stress and restore a sense of calm and focus.

Maintaining landscape plantings on Boston’s dense streets is challenging. Sidewalk space is at a premium and the hard surfaces required to support concentrated activity can be hostile to trees and other plantings. Soil compaction, lack of rooting space, poor soils, road salt, temperature fluctuations, physical damage, and even air pollution and litter all put stress on plants. These guidelines seek to balance the benefits of a healthy greenscape with the realities of limited space and the ongoing need for care and maintenance.

The guidelines in this section are intended to enable street trees and plantings to thrive, and to use stormwater as a resource to support plant life and replenish groundwater. The following sections provide a discussion of the benefits of street trees, plantings, and vegetated stormwater management along sidewalks, as well as the importance of soil selection and management in cultivating plant life.

Phytoremediation/ Phytotechnologies

Phytoremediation or phytotechnologies—the use of plants to clean, remove, and stabilize contaminants—should be strongly considered in the design of greenscape elements. Many common organic contaminants, including petroleum hydrocarbons, can be easily processed and degraded by plants and associated soil biology. Contaminants are found in stormwater, air, existing site soils, and groundwater; it is encouraged that plantings not only be designed to treat stormwater, but other pollution sources as well. Greenscape can be designed to prevent the spread of contamination spills before they occur, or to remediate areas where a previous contamination is suspected. This is especially important on Industrial Street Types, in maintenance yards, brown fields, and other areas where high concentrations of pollutants may be of concern. For additional information on phytoremediation, please refer to the Environmental Protection Agency’s website page on Contaminated Site Clean-Up Information (CLU-IN) and phytotechnologies.

Greenscape elements in the public right-of-way must be approved by the Boston Parks Department and PWD. Enhanced and pilot treatments will require special maintenance agreements.

Benefits of Street Trees

Environmental

- ▶ **Reduced energy use and heat island effects:** Trees reduce energy use by shading buildings and cooling the air through transpiration. A study on heat island effects in New York City concluded that trees and green roofs substantially reduce air temperatures, with street trees providing the most cooling per unit area.* ①
- ▶ **Reduced greenhouse gases and airborne particulates:** Trees reduce greenhouse gases by sequestering carbon dioxide and reducing the need for air conditioning. Trees also improve air quality by capturing gaseous pollutants and particulates in the tree canopy surface. Street trees have

been shown to remove as much as 60% of the airborne particulates at street level. ②

- ▶ **Improved water quality and groundwater recharge:** Trees capture rainfall in their leaves and in the soil, trapping sediments, breaking down organic pollutants, and stabilizing non-organic pollutants such as metals. Trees also reduce the volume and temperature of stormwater runoff and help recharge groundwater. ③
- ▶ **Support of natural diversity:** Trees make beneficial use of rainfall and runoff to support the growth of the urban forest ecosystem. ④

* Rosenzweig, Cynthia et al. Mitigating New York City's Heat Island with Urban Forestry, Living Roofs, and Light Spaces. New York City Regional Heat Island Initiative, Final Report. Albany: New York State Energy Research and Development Authority Report 06-06, October, 2006.

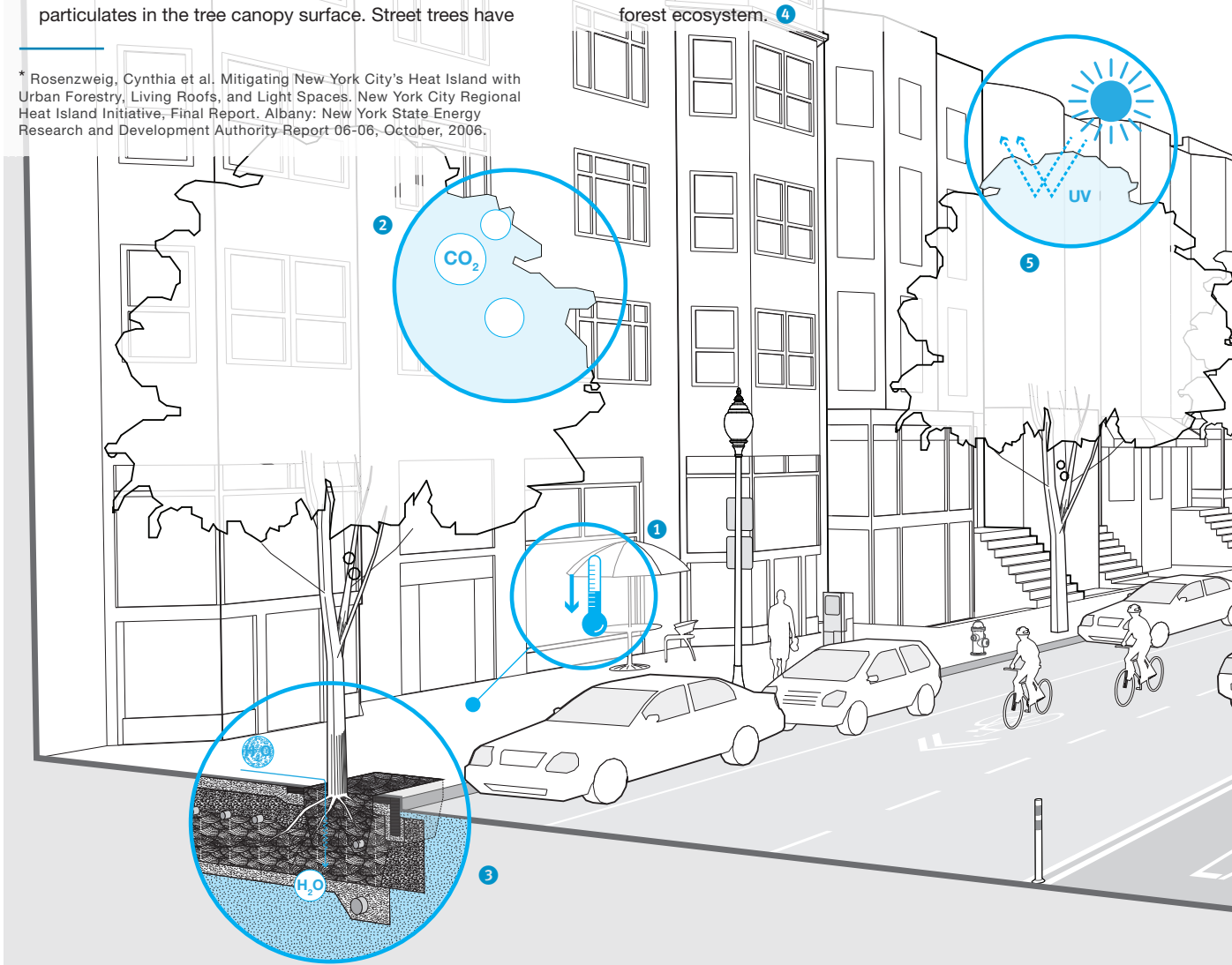

Social

- ▶ **Enhanced comfort, beauty, and attractiveness of streets and public spaces:** Trees provide shade and scale; define and accentuate streets and spaces; and provide a soft, colorful counterpoint to the hard surfaces in the city.
- ▶ **Reduced stress and improved concentration:** Studies have shown that even brief encounters with nature at a small scale can reduce stress and mental fatigue, restoring the ability to focus and concentrate.[†]
- ▶ **Reduced exposure to UV rays:** Shade provided by street trees makes it possible to walk, bicycle, and linger in public spaces with reduced risk of sunburn, skin cancer, and other harmful effects of UV rays.[‡]
- ▶ **Symbolic connection to the natural world:** Trees in the urban environment are reminders that nature is ubiquitous and interconnected through the climate, seasons, and the larger ecosystem.

Economic

- ▶ **Improved comfort and appeal of retail districts:** In preference surveys, consumers indicate a willingness to travel further, stay longer, visit more frequently, and even pay more for parking in shaded, well-landscaped business districts.[‡]
- ▶ **Perception of quality and care, which extends to adjacent businesses:** Healthy trees signal that a place is well managed and maintained. This benefits the image of adjacent businesses, suggesting attention to detail and good customer service.
- ▶ **Increased residential property values:** Trees on streets and in front yards add value to home properties, with increases generally in the range of 7% for homes in areas with good tree cover.[§]

[†] Kaplan, Stephen. The Restorative Benefits of Nature: Toward an Integrative Framework. *Journal of Environmental Psychology* (1995), Volume 15, p. 169-182.

[‡] Wolf, Kathleen. Business District Streetscapes, Trees, and Consumer Response. *Journal of Forestry* (December 2005), Volume 103, No. 8. pp. 396-400.

[§] Wolf, Kathleen. City Trees and Property Values. *Arborist News* (August 2007), pp. 34-36.

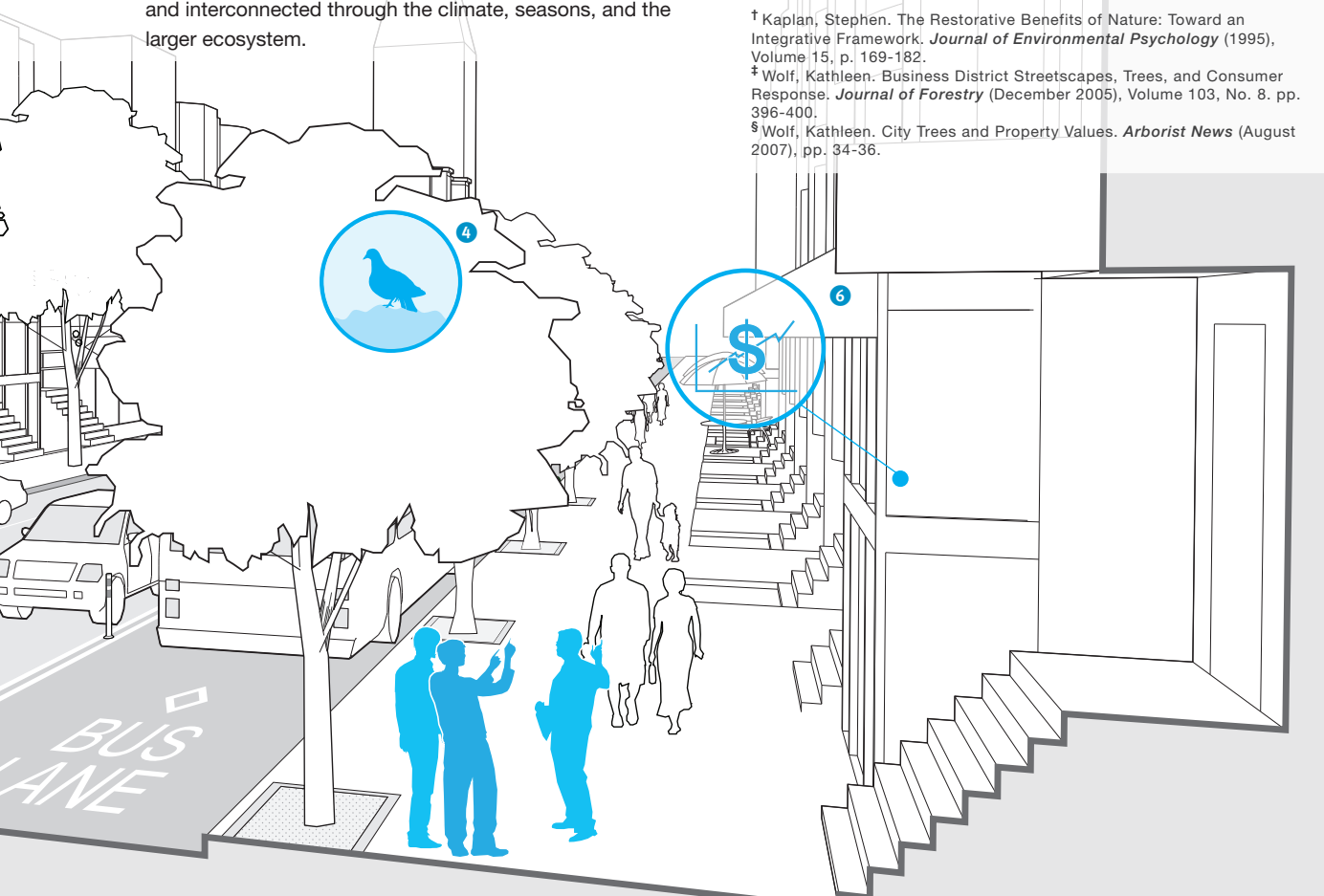

Benefits of Vegetated Stormwater Management

Overview

Boston's streets and sidewalks are one of the city's most valuable resources, and they offer tremendous opportunities to improve stormwater management. New green strategies for managing runoff along streets and sidewalks can reduce flooding, increase groundwater recharge, and reduce pollution to our rivers and streams as well as to Boston Harbor. Capturing rainfall before it flows into the city's drainage and sewer system can also help reduce sewer overflows and save the city money on upgrading and repairing infrastructure. Many of the best techniques for managing stormwater runoff use trees and other vegetation to capture rainwater as it falls, and to collect and filter runoff from streets, sidewalks, and other paved areas. Increasing vegetation also helps keep streets cooler, both by the shade from large trees, and by evaporation and plant transpiration, which cool the air just as perspiring cools the skin.

The City of Boston encompasses just over thirty-one thousand acres of land, over half of which is paved over with streets, buildings, and parking lots. Stormwater runoff from Boston flows into four major watersheds: the Charles River, the Mystic River, the Neponset River, or directly into Boston Harbor. Boston also has a major challenge maintaining groundwater levels, mainly in areas that are on filled land that was previously open water and marsh. In these areas, wood pilings that support many buildings may rot if groundwater levels drop. Recharging stormwater rather than directing runoff into pipes is one strategy to maintain groundwater levels.

The City of Boston owns and controls about one quarter of the land area of the city, and over half of city-owned property is streets and roads. The streetscape is one of the city's best areas for controlling and managing stormwater runoff.

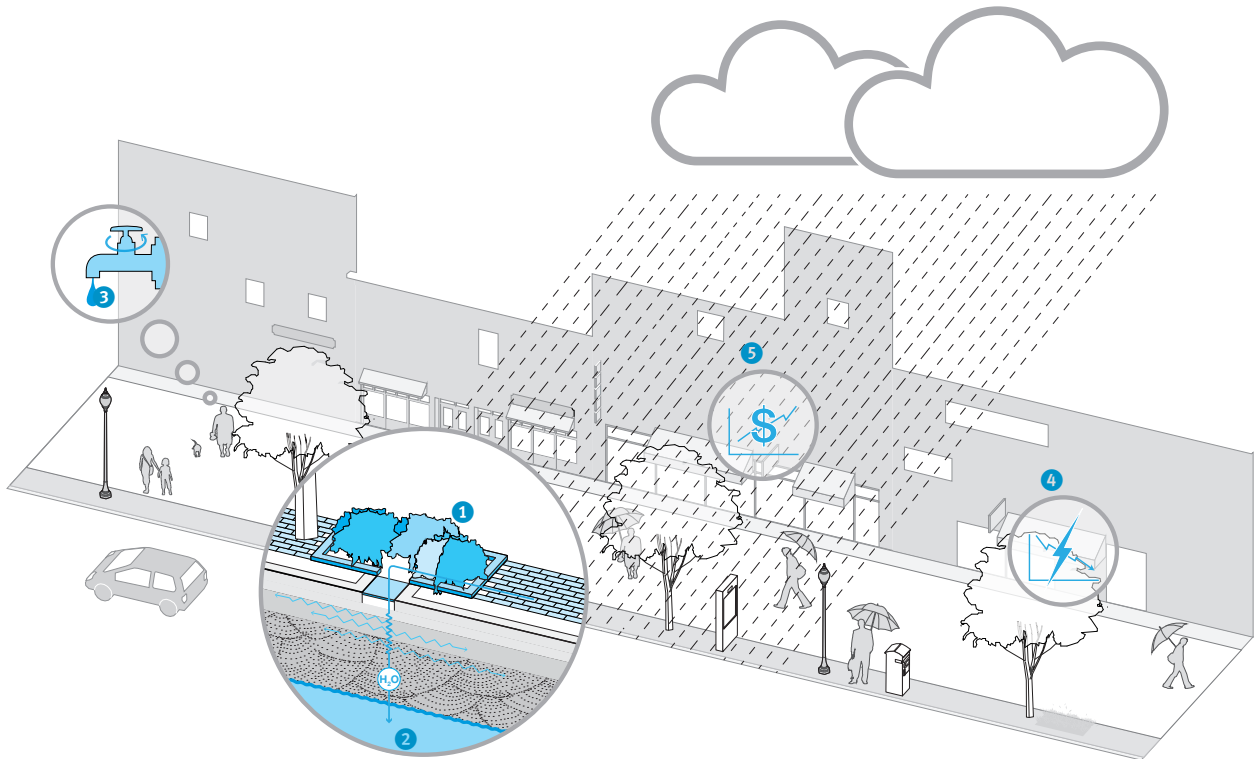

Environmental

- ▶ **Reduced pollution to rivers and the harbor:** Stormwater is the main source of pollution to Massachusetts' waters. When rain falls, it washes pollutants from the roads, lawns, and built environment into local waterways. Stormwater can also cause overflows of “combined” sewers—sewer pipes that carry both sanitary sewage and stormwater in the same pipe. Reducing the amount of stormwater runoff from urban areas will reduce pollution from direct runoff and from combined sewer overflows. Phytoremediation, or the use of plants to filter pollutants, is another benefit of vegetated stormwater management techniques. 1
- ▶ **Decreased flooding:** By capturing more stormwater in trees and vegetation and by recharging more of it back into the ground, there will be less street flooding and lower peak flows, which often cause flooding of local streams and low lying areas.
- ▶ **Increased groundwater recharge:** Healthy vegetation and porous soils dramatically increase how much rainfall filters into the soil instead of running off into storm drains. Increasing recharge and decreasing runoff can help 2 maintain Boston's groundwater levels.
- ▶ **Reduced energy use:** When stormwater flows into the combined sewer system, it is carried out to the Deer Island Wastewater Treatment Plant, where it is treated and discharged out into Massachusetts Bay as if it were sanitary sewage. Keeping stormwater out of the sewer system 4 reduces the use of energy to pump and treat this water. Increased urban vegetation can also reduce ambient air temperatures, reducing the demand for air conditioning

Social

- ▶ **Enhanced understanding of water:** When people see water flowing into planted areas in the urban environment, rather than disappearing into underground drains, they are more likely to 3 understand the importance—and the challenges—of managing water in urban areas.
- ▶ **Increased support for stormwater management:** Visible stormwater management in the public right-of-way can increase people's awareness of water pollution and the importance of taking action to protect the environment. Individual activities like picking up pet waste, reducing litter, and improving lawn care practices can reduce pollution in runoff.
- ▶ **Sense of connection to Boston's water resources:** In Boston, streets function like small streams, carrying stormwater to rivers and harbors. People can appreciate these connections even when they are far away from the water.

Economic

- ▶ **Reduced costs for wastewater treatment:** When less water enters the combined sewer system, 4 wastewater treatment costs can be lowered.
- ▶ **Potential capital project savings:** In many cities, stormwater management systems designed to mimic natural processes, also called “green infrastructure,” have been found to be less expensive than conventional pipe and gutter systems or “gray infrastructure.”
- ▶ **Potential to create new green jobs:** The installation and maintenance of vegetated stormwater treatment systems requires a combination of engineering, construction and operational labor skills. There is significant potential for job creation and growth in these fields as stormwater management requirements become more demanding.
- ▶ **Enhanced property values:** Numerous economic studies have shown that property values are higher in areas where there are water features, open space, and vegetation in the public right-of-way. Designing stormwater management systems to provide public amenities such as open streams, ponds, and street trees will 5 increase overall economic benefit.

Soils Selection and Management

Overview

Proper soil selection and management is one of the best ways to support healthy vegetation and to improve stormwater management in urban areas. Healthy soils—soils that have a high organic content and plenty of pore space—support healthier trees and plants and promote more groundwater recharge and better filtration of stormwater. Heavily compacted soils act almost like pavement, absorbing little water, and supporting less biological activity than well aerated soils.

Existing trees and planted areas that have become compacted and degraded can be significantly improved with aeration to restore porosity and/or the addition of soil amendments, such as weed-free compost, to help retain soil moisture. Soil improvements can make a significant difference in the health

and longevity of trees and other vegetation. They can also improve stormwater management. Soil maintenance should be part of an operation and maintenance plan for urban vegetation.

New street trees and plantings present an opportunity to use engineered soils to grow a much larger and healthier greenscape and to clean and recharge significant volumes of stormwater runoff. Design details for planting street trees and implementing vegetated stormwater management techniques are found in the following sections. In all of these applications, careful selection of soil type and providing maximum soil volume should be priorities.

Soils with sufficient organic content and pore spaces provide plant roots with nutrients, water, and oxygen for healthy growth.



In constrained situations where existing street trees cause sidewalk heaving or where space is limited, consider using structural soils. Structural soils are a type of engineered soil that is designed to meet the load bearing requirements of urban streets while still maintaining adequate porosity and organic content to support healthy vegetation. Some structural soils also contain materials that specifically retain moisture. In urban contexts, structural soils allow the placement of ample, healthy soil beds beneath sidewalks and parking areas. Trees and plantings can be grown in dense urban settings with paved surfaces above the root systems, provided there is a way for water to enter the structural soil mixture.

Structural soils require irrigation (passive or active) to support a variety of plant types. Overflow drains may be necessary depending on the characteristics of the surrounding soils. Structural soil applications can both provide a healthier environment for plants and better capture, filter, and recharge of stormwater.

As an alternative to structural soils, soil cell systems can be used to provide appropriate soil volumes. See Covered Tree Trenches later in this chapter for more information about structural soils.

Honeylocust growing in a covered tree trench that provides 450 cubic feet of planting soil per tree.





Street Trees

56	Street Trees and Urban Design
57	Street Trees and Street Types
58	Choosing the Right Tree
59	Tree Siting and Spacing
60	Root Environment for Street Trees
61	Open Tree Trenches
62	Covered Tree Trenches
63	Raised Tree Beds
64	Tree Pits

Street trees help define many of Boston’s best-loved streets and are a critical component of Boston’s urban forest ecosystem. This section describes how and where to plant street trees to achieve both environmental and urban design benefits.

Any resident of Boston can request to have a street tree planted in front of their home or business, provided the sidewalk is wide enough, by calling the Park Line at 617-635-PARK (7275). An arborist must inspect the site to determine if a tree can be planted.

The Boston Parks Department oversees maintenance and planting of trees in the public right-of-way. The maintenance program includes pruning, disease control, removal, and storm damage repairs. The Department’s oversight includes review and approval of trees to be planted by others and the planting of new trees throughout Boston’s neighborhoods. Tree selection and planting design in the public right-of-way must be approved by the Boston Parks Department and PWD.

Grow Boston Greener and Boston’s Climate Action Plan

The City has partnered with a coalition of environmental and community organizations to form the Boston Urban Forest Coalition in an effort called “Grow Boston Greener,” which seeks to increase tree canopy cover in the City by planting 100,000 trees by 2020. By the time the trees are mature in 2030, the tree canopy cover is expected to increase from 29% to 35%.

Grow Boston Greener is a component of Boston’s Climate Action plan. The major goals of Grow Boston Greener are to:

- ▶ Increase the tree canopy cover in the City, particularly in environmental justice and low canopy areas
- ▶ Mitigate the urban heat island effect and reduce energy consumption through the appropriate placement of trees on residential and commercial properties
- ▶ Improve stormwater management through strategic neighborhood plantings
- ▶ Improve air and water quality

Street Trees and Urban Design

Street trees can be used to serve a variety of urban design functions. Based on their location, arrangement, and spacing trees can:

- ▶ Frame, define, and accentuate spaces
- ▶ Emphasize linearity and long views
- ▶ Create a ceiling and sense of enclosure
- ▶ Provide needed shade and filtered light
- ▶ Reinforce the rhythm of a streetwall
- ▶ Add texture, delight, and human scale

Iconic plantings of street trees associate neighborhoods with seasons, and contribute to a unique sense of place. Red oaks in autumn on the Jamaicaaway embody the essence of New England. Magnolias in bloom on Commonwealth Avenue mark the arrival of spring.

Trees are an ideal form of shade, providing protection on hot summer days while allowing heat and light to penetrate during cold winter months. **They can also calm traffic by narrowing the apparent width of the roadway.**

Street trees should be used in thoughtful compositions that respect the overall street context, local environment, and adjacent land uses.



Street Trees and Street Types

Street trees should be considered in every street design project; however, on some Street Types, trees are essential. For example, Boulevards and Parkways are defined in large part by the presence of trees. Below are guidelines for using trees on Boston's Street Types.

Parkways are lined with continuous green spaces for trees, either on the sides or in the median. If sufficiently wide, green spaces provide an excellent rooting environment for large-stature shade trees. Trees should be planted no more than  **40' apart** to help create a continuous canopy. Species of a similar size, scale, and form should be planted along the length of the road for consistency and to maximize visual impact. Avoid monocultures, as disease and insects may destroy street trees along an entire street.



Trees on **Boulevards** are planted at regular intervals in a formal pattern with street lights, emphasizing linearity and long perspective views. The pattern draws the eye to the horizon or to an important terminus, such as the State House on Beacon Street, the Public Garden on Commonwealth Avenue, or the Blue Hills on Blue Hill Avenue. Trees are planted in the Greenscape/Furnishing Zone and are usually surrounded by pavement. Modern planting techniques such as covered tree trenches should be used to provide sufficient soil volume. Large-stature shade trees of similar size, scale, and form are typically planted  **30' apart** to create a continuous canopy.

Neighborhood Connector Streets are similar to Boulevards but are less formal. Trees should be planted where they can best survive, such as in open or covered tree trenches.

Neighborhood Main Streets benefit enormously from trees, as visual preference studies have found commercial districts with shade trees are consistently preferred over districts without trees. Shade trees create the sense of an outdoor room and make streets more comfortable for sitting, café dining, window browsing, and socializing. Trees should complement and not interfere with first floor uses, entryways, cafés, or other activities in the Frontage Zone. Trees should not be planted in loading zones. Limbs should be pruned to maintain sight lines and maximize visibility of the street wall. Different species can be used in clusters to highlight special areas and create a sense of place.

Large canopy shade trees are attractive and add value to homes on **Neighborhood Residential Streets**. They help keep homes cool in the summer while allowing light and heat to penetrate in colder months. The branches also have the benefit of tempering winter winds. Street trees should be spaced far enough apart to allow light to reach front lawns and gardens. Open tree trenches or front yards (with permission from owners) should be used where possible to maximize rooting space.



Downtown Commercial and **Downtown Mixed-Use Street Types** require trees that can adapt to low light depending on building heights, street width, and street orientation. Where there is insufficient rooting depth due to underground utilities, raised tree beds can be considered.

Trees in **Industrial** settings must be able to withstand drought and harsh conditions resulting from heavy traffic, green-house gas (GHG) emissions, and heat island effects from surrounding lots. Where possible, trees should be set back from the street and planted in continuous filter strips between the paved lots and the sidewalks. Tree species that can uptake and remove urban contaminants and air pollutants should be considered wherever possible.

Choosing the Right Tree

Tree selection needs to address the ability of the tree to mature in a given microclimate, as well as its ability to meet design objectives. Scale and form are key design considerations.

Large canopy shade trees play a critical role in the urban forest ecosystem, and offer a unique presence on city streets. Providing sufficient rooting space is a challenge, however this does not limit plantings to smaller trees; even small trees will suffer in a limited rooting environment. Given all the uncontrollable variables in a street it is worth taking a chance that a shade tree will survive in less than ideal conditions. Appropriate details should be used to enable trees to grow without roots rising to the surface and deforming sidewalks.

Choosing a tree for the right habitat can help minimize conflicts with adjacent infrastructure. For example:

- ▶ Shallow rooted species should be considered near sewer or drain pipes
- ▶ Open-form trees should be considered near overhead wires
- ▶ Trees with deeper roots and small trunk flares should be used adjacent to pavements

Other considerations for selecting the right tree include: the scale and form; sight line requirements; the type of microclimate; tolerance to drought and insects; inundation; resistance to vehicular emissions and salt; the ability to remediate pollutants; and the amount of maintenance. From an aesthetic perspective, spring flowers, fall color, the quality of light and shade, and the abundance of fruit, nuts, and leaf litter should also be considered.

Examples of Parks Department Approved Street Trees



Large-Stature Shade Trees

Used for: Larger scale streets (Especially Boulevards, Parkways) and plazas

Canopy and form: Spreading to create a continuous canopy

Sample species: Sweetgum; Red Oak; Silver Linden; Zelkova



Medium-Stature Trees

Used for: Smaller scale streets and plazas

Canopy and form: Spreading or columnar

Sample species: Red Maple, Honey Locust; Chinese Elm; Black Tupelo

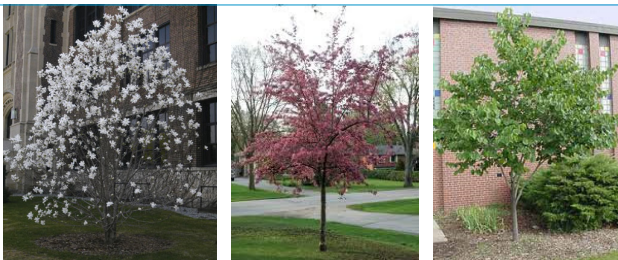

Short-Stature and Ornamental Trees

Used for: Planters, plazas, and areas with utility wires

Canopy and form: Spreading or columnar

Sample species: Hedge Maple, Cherry, Goldenraintree, Shadblow (single-stem)

A complete list of Boston Parks Department approved street trees is available on their website.

Tree Siting and Spacing

Trees should be planted in locations that provide the best conditions for growth within a given design framework. This could mean planting in private yards in residential areas (with permission from owners), or clustering trees in open planting areas on wide sidewalks or in plazas. Large, contiguous planting areas should be employed where feasible to enable large canopy shade trees to reach maturity.

Street tree plantings should strive for continuity along a street while respecting adjacent uses. Each tree should complement and not interfere with first floor uses, entryways, cafés, or other activities in the Frontage Zone. Trees should not be planted in loading zones or within 10' of bus stop landing zones. Trees limbs should be pruned to maintain sight lines and maximize visibility of the street wall.

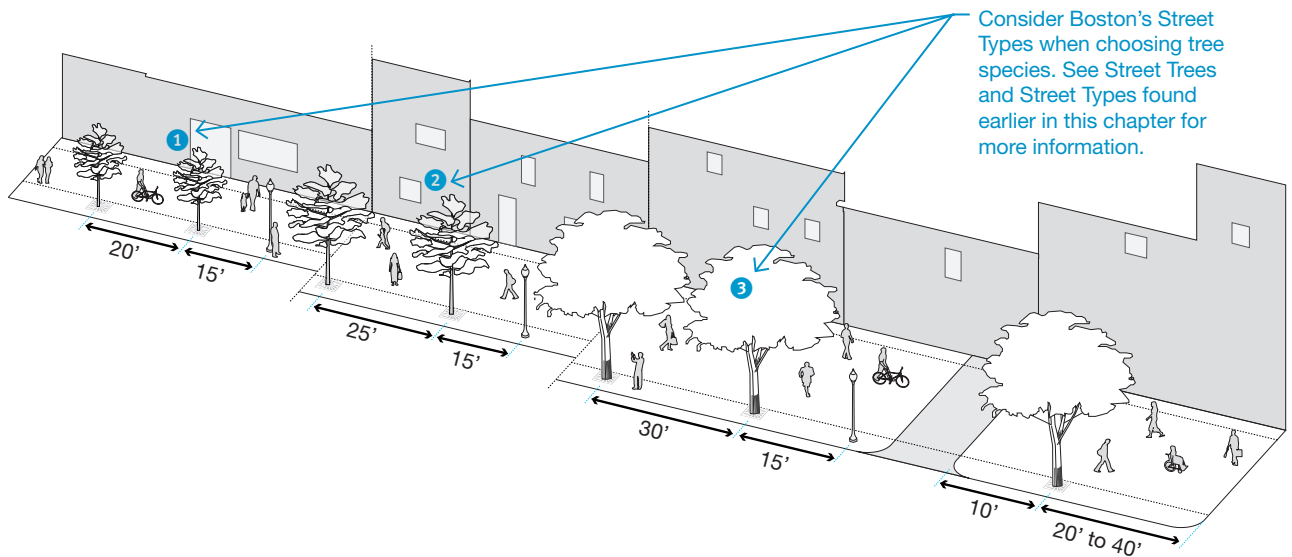

Preferred Tree Spacing and Offsets

	1 Short Stature Ornamental Trees	2 Medium Stature Trees	3 Large Stature Shade Trees
On-Center Spacing	20'	25'	30'
Offset from Curbs or Path Edges	2'-6"	2'-6"	2'-6"
Offset from Light Poles	15'	15'	15'
Offset from Driveways, Fire Hydrants, Loading Zones	10'	10'	10'
Offset from Intersections (Depending on direction of traffic)	20'	20' to 40'	20' to 40'

The following guidelines have been developed for tree spacing and offsets. Note: Where site-specific conditions prohibit meeting the guidelines, trees should be considered at the discretion of the Boston Parks Department.

Root Environment for Street Trees

The ability of a tree to grow beyond a certain size is directly related to the volume of soil available for roots. Providing sufficient rooting soil in a dense, urban environment can be costly, but is worthwhile given the unique benefits that mature shade trees provide.

Tree roots do not survive well in highly compacted soil because it lacks the void spaces needed for air and water to circulate. Roots in compacted soil will migrate toward the surface for air and water, causing sidewalks to crack and heave.

When the rooting space is severely constrained, the tree roots will grow to capacity, and then the tree will decline and die.

Trees in the Northeast U.S. need approximately  **2 cubic feet of soil per square foot of canopy area.**[†] For example, a tree growing in a constrained 3' by 8' by 4' pit would be expected to reach about an 8' diameter canopy before becoming stressed and showing signs of decline. If the tree has access to soil outside the pit, the canopy can grow much larger.

Landscaped areas in the Frontage Zone or on the edge of adjacent properties (with permission from owners) can be excellent places to plant trees, as they may offer open areas for roots to spread. Examples include the residential edges on Commonwealth Avenue, where most of the iconic Magnolias are planted. When open landscape areas are not available, more intensive strategies are required.

The last decade has brought several innovations in engineered soils and sidewalk designs to support root growth. Below are four strategies for planting trees in constrained sidewalk settings. These strategies are intended to increase the volume of rooting soil while maintaining accessible sidewalks, and are discussed in detail on the following pages.

Methods include:

- ▶ Open Tree Trenches
- ▶ Covered Tree Trenches
- ▶ Tree Pits
- ▶ Raised Tree Beds

[†] Urban, Jim. *Up By Roots, Healthy Soils and Trees in the Built Environment*. International Society of Arboriculture, Champaign Illinois. 2008

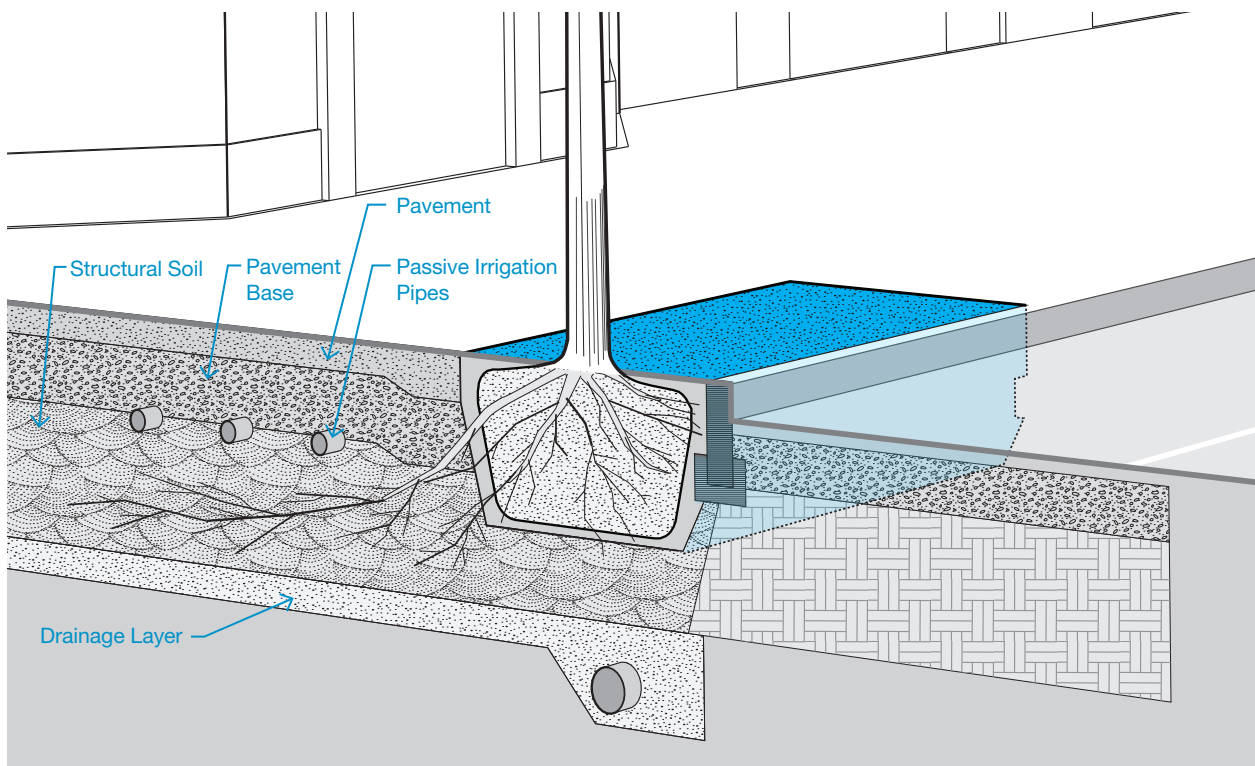

Open Tree Trenches

Overview

An open tree trench is an area of soil connecting a row of trees that is covered with mulch, groundcover, grass (or “tree lawn”), or other greenscape. Tree trenches are generally located in the Greenscape/Furnishing Zone, though they can also be located in the Frontage Zone. For stormwater benefits, the sidewalk should be pitched toward the open tree trench. Non-linear open tree areas can also be used for planting trees in clusters.

Trees planted in open tree trenches and areas with a sufficient amount of uncompacted soil have the greatest chance of surviving and thriving in an urban environment.

Use

- ▶ Curbside open tree trenches or “tree lawns” are commonly used on Neighborhood Residential Street Types.
- ▶ Provide as large of a trench as needed for sufficient rooting volume while maintaining appropriate sidewalk clearances. The typical size of a tree trench is **4' wide by 3' deep**. If sidewalk constraints prohibit wider tree trenches, smaller trenches, as narrow as **2'-6" wide**, may be approved.
- ▶ Existing trenches that are smaller may be replanted at the discretion of Boston Parks Department.
- ▶ Plant the tree so that the top of the root ball is flush or nearly flush with the surrounding soil.
- ▶ The surface of the tree trench should be level with the sidewalk to avoid creating a tripping hazard.

Considerations

- ▶ Areas with heavily-used, high-turnover curbside parking are not compatible with open tree trenches, as the soils become compacted over time. Consider including pavement breaks to provide intermittent access to parking.
- ▶ Consider planting bare-root trees (trees with no soil around the roots). Confirm with Boston Parks Department or a tree nursery specialist if bare-root planting is appropriate for the given species and timing.



Covered Tree Trenches

Overview

A covered tree trench is a linear trench covered by pavement designed to support root growth while providing structural support for sidewalks. A covered tree trench makes it possible to have large canopy shade trees in even the most constrained urban environments.

Support for the sidewalk is typically provided by using engineered structural soils. Structural soil is designed to be loose enough to allow air exchange, water movement, and root growth, yet compactable enough to support pavement^{II}. Soil cells and structural soils can be used in clusters around trees as well as in a linear trench if needed to avoid underground obstructions.

Tree trenches should be covered with pavement and permit passive irrigation to allow water to reach the soil. Provisions may include the use of pervious pavement or flexible, perforated pipes beneath the pavement.

Covered tree trenches are considered an enhanced treatment and require a special maintenance agreement.

^{II}The use of prefabricated "soil cells" or suspended sidewalks may also be considered.

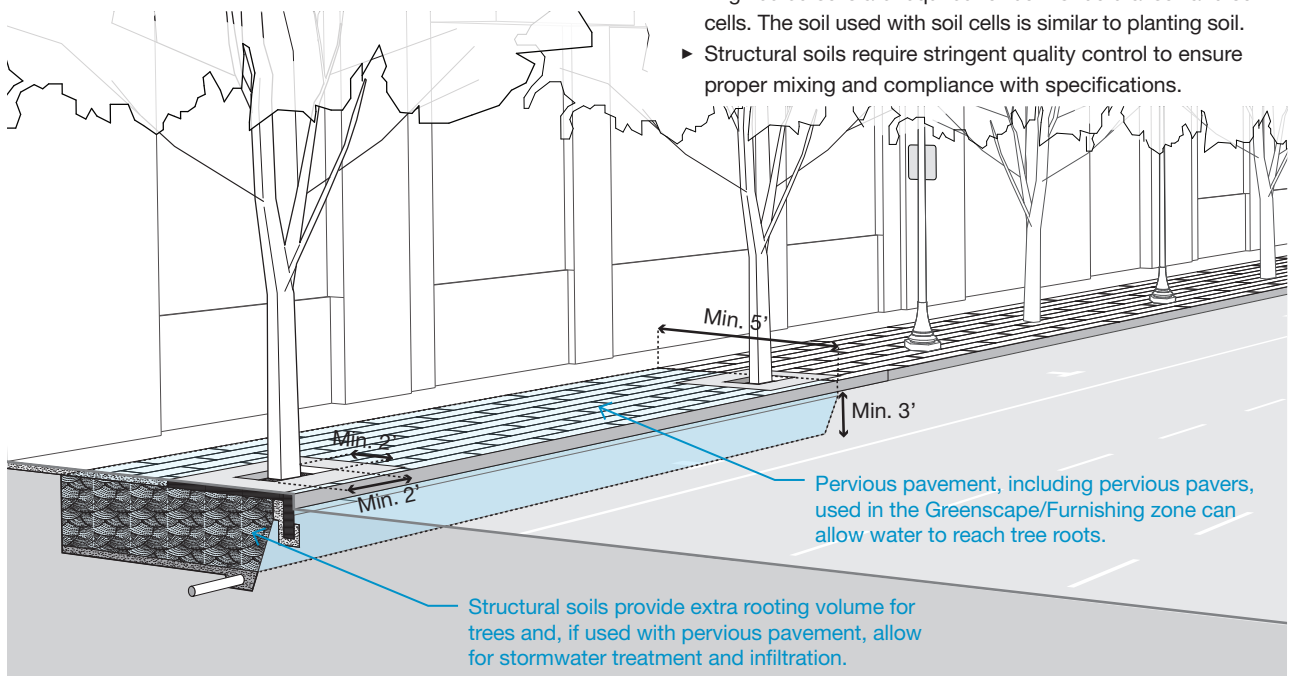

Use

- ▶ Use covered tree trenches in locations with heavy pedestrian traffic and high turnover parking.
- ▶ Provide as large a trench as needed for sufficient rooting volume. The trench should be at least **5' wide by 3' deep**, and should provide at least **450 cubic feet** of soil for a single tree, or **350 cubic feet** of soil per tree if the space is shared among several trees in a cluster. Plant the root ball nearly flush with the surrounding pavement, allowing for the depth of any covering such as pavement or mulch.
- ▶ Provide an opening around the trunk of **2' by 2'** covered with mulch during the initial years; however keep the mulch away from the base of the trunk. Over time the roots in this zone will expand and thicken with bark, eliminating the need for mulch.
- ▶ Provide subsurface drain lines in areas where the subgrade drains poorly. If in doubt, install drainage infrastructure.
- ▶ Covered tree trenches must meet required load bearings.

Considerations

- ▶ Consider covered tree trenches whenever sidewalks are being replaced along the length of a corridor.
- ▶ Engineered soils are required for both structural soil and soil cells. The soil used with soil cells is similar to planting soil.
- ▶ Structural soils require stringent quality control to ensure proper mixing and compliance with specifications.

Raised Tree Beds

Overview

Raised tree beds can be appropriate for planting trees in locations where utilities or subsurface conditions prohibit planting in the ground. However, tree growth is strictly limited by the size of the raised bed. In this constrained situation, smaller stature trees should be considered.

Raised tree beds can also provide seating if the height is between  **16" and 2'**, with **20"** being the preferred height. They can also be used to define spaces and provide a sense of enclosure in plazas and other open sidewalk areas.

Use

- ▶ Size raised tree beds as large as needed to provide sufficient rooting volume while maintaining appropriate sidewalk clearances.
- ▶ Clustering trees in large planters is a good strategy to provide greater soil volumes to individual trees.
- ▶ If there is subsurface space available for root growth, provide a shallow layer of structural soil below the adjacent pavement.
- ▶ Provide subsurface drain lines in areas where the subgrade drains poorly. If in doubt, install drainage infrastructure.

Considerations

- ▶ Raised tree beds should not obstruct the Pedestrian Zone and should only be used in sidewalks of generous width to avoid creating a tripping hazard.
- ▶ Consider slightly smaller container grown tree stock for raised tree beds.
- ▶ Consider planting bare-root trees. Confirm with Boston Parks Department or a tree nursery specialist if bare-root planting is appropriate for the given species and timing.

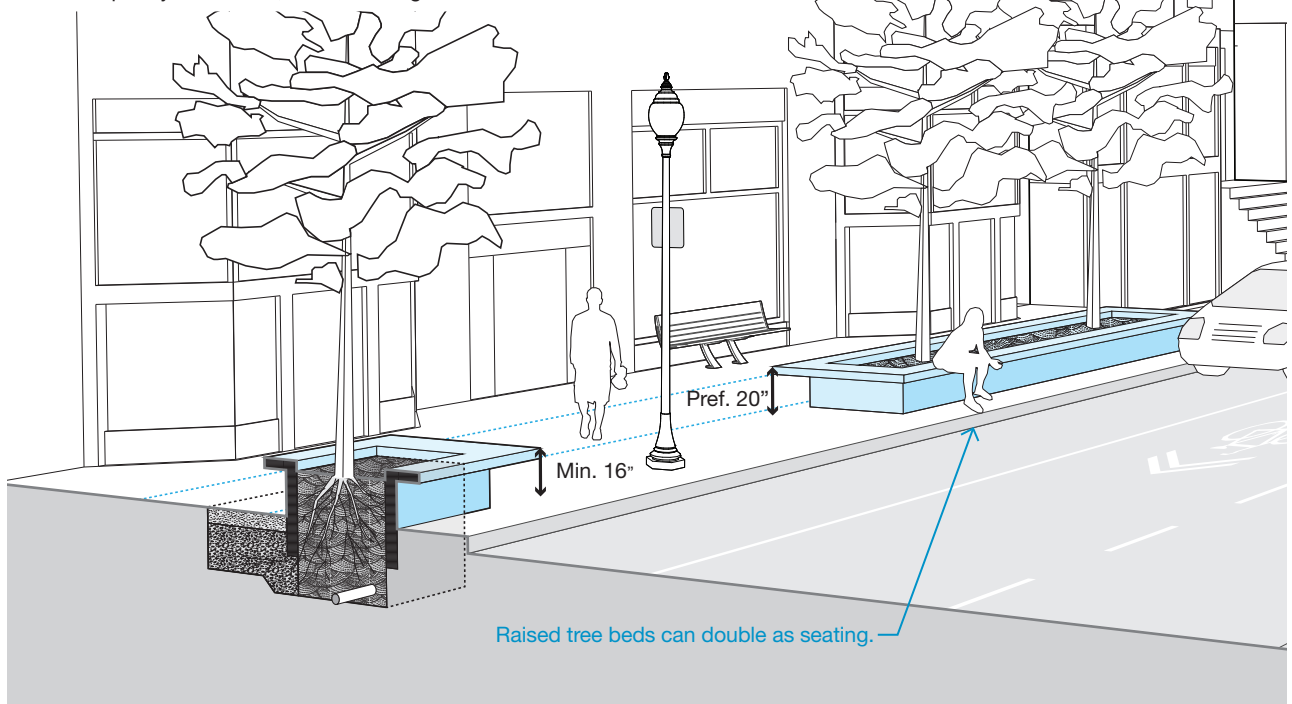

Tree Pits

Overview

Tree pits are used where space or resources do not permit the use of open or covered tree trenches. The tree pit should be made as large as possible to provide maximum rooting volume while maintaining the appropriate clear width for the Pedestrian Zone. The sides of the pit below the sidewalk should be open to the surrounding subgrade to allow for root penetration beyond the pit.

Tree grates require maintenance to adjust for tree growth and to correct for any settlement that may cause a tripping hazard. Tree grates are considered an enhanced treatment and will require a maintenance agreements.

Use

- ▶ Provide as large a tree pit as feasible while maintaining appropriate sidewalk clearances. The preferred size for a tree pit is at least **4' by 10' by 3' deep or 120 cubic feet**. Smaller tree pits, as narrow as 2'-6" wide, may be approved if sidewalk constraints prohibit the construction of a full size tree pit.
- ▶ Existing tree pits that are smaller than the recommended minimum may be replanted at the discretion of Boston Parks Department.
- ▶ Plant the tree so that the root ball is nearly flush with the surrounding pavement while allowing for the depth of any mulch or covering.

Create tree pits as large as possible to provide maximum rooting volume while maintaining the appropriate clear width for the Pedestrian Zone.

Min. 3'

Considerations

- ▶ Provide an opening around the trunk of  **2' by 2'**. The remainder of the pit should be covered with mulch, pervious pavers set in sand, or, if there is a maintenance agreement, a tree grate. If mulch is used, keep it away from the base of the trunk. Over time the roots in this zone will expand and thicken with bark, eliminating the need for mulch.
- ▶ Install a wrapped 4" perforated water/aeration tube in each tree pit per the most current approved Boston Parks Street Tree planting details.
- ▶ Pitch the sidewalk toward the tree pit to use stormwater for irrigation.
- ▶ Provide at least 50% new soil and scarify soils at the interface with adjacent soil to promote blending. Depending on the project site and soil conditions, the amount of new soil may vary.
- ▶ Where sidewalk space is limited and minimum dimensions cannot be achieved with the installation of street trees, consider providing curb extensions.
- ▶ The surface of a tree grate is not counted toward the width required for an accessible pedestrian pathway.
- ▶ Tree grates must have break-out pieces around the trunk to allow for growth.
- ▶ Consider slightly smaller container grown tree stock for tree pits.
- ▶ Consider planting bare-root trees. Confirm with Boston Parks Department or a tree nursery specialist if bare-root planting is appropriate for the given species and timing.

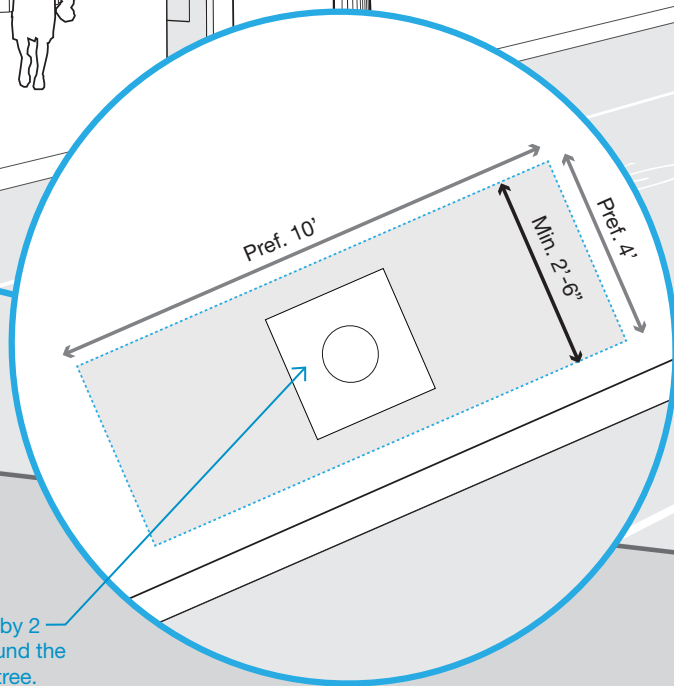

Provide a 2' by 2' opening around the trunk of the tree.

Street Tree Species and Heights

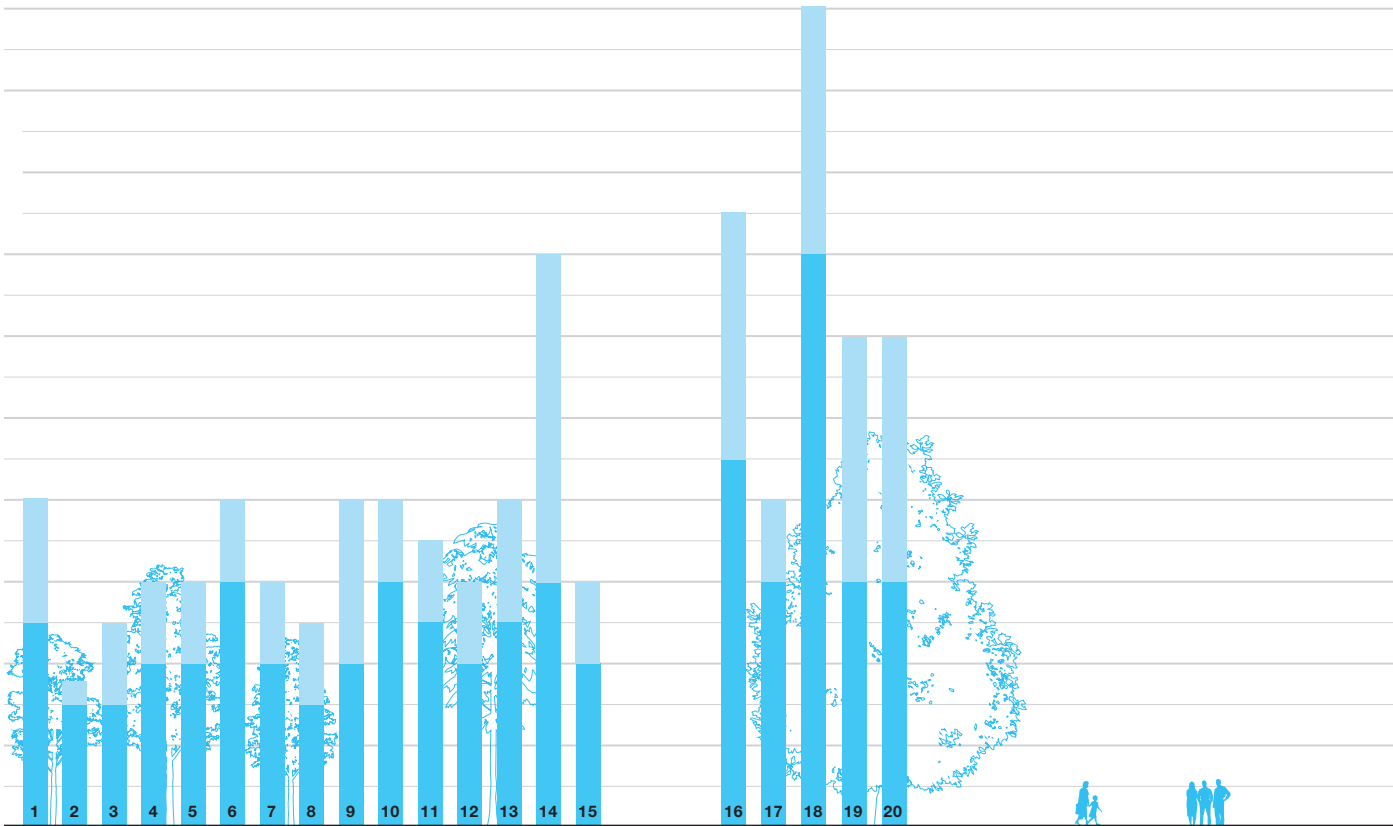

Under Wire Species (Shorter Trees)



	Scientific Name	Common Name	Height (Ft)
1	<i>Acer campestre</i>	Hedge Maple	25-40
2	<i>Acer ginnala</i>	Amur Maple (single-stem)	15-18
3	<i>Amelanchier canadensis</i>	Shadblow Service berry (single-stem)	15-25
4	<i>Cercis canadensis</i>	Eastern redbud (single-stem)	20-30
5	<i>Crataegus crusgalli</i> 'var. inermis'	Thornless Cockspur Hawthorn	20-30
6	<i>Koelreuteria paniculata</i>	Goldenraintree	30-40
7	<i>Maackia amurensis</i>	Amur maackia	20-30
8	<i>Malus</i>	Crab Apple	15-25
9	<i>Parrotia persica</i>	Persian Parrotia, Persian Ironwood	20-40
10	<i>Prunus x. 'autumnalis'</i>	Cherry	30-40
11	<i>Prunus x. sargentii</i>	Cherry	25-35
12	<i>Prunus x. yedoensis</i> Yoshino	Cherry	20-30
13	<i>Ostrya virginiana</i>	American Hophornbeam	25-40
14	<i>Gleditsia triacanthos</i>	Honeylocust	30-70
15	<i>Syringa reticulata</i>	Japanese Tree Lilac	20-30

Evergreens



	Scientific Name	Common Name	Height (Ft)
16	<i>Abies balsamea</i>	Balsam Fir	45-75*
17	<i>Abies fraseri</i>	Fraseri Fir	30-40*
18	<i>Metasequoia glyptostroboides</i>	Dawn Redwood	70-100*
19	<i>Picea pungens</i>	Colorado Spruce	30-60*
20	<i>Picea glauca</i>	White Spruce	30-60*

* = Not a Recommended Street Tree

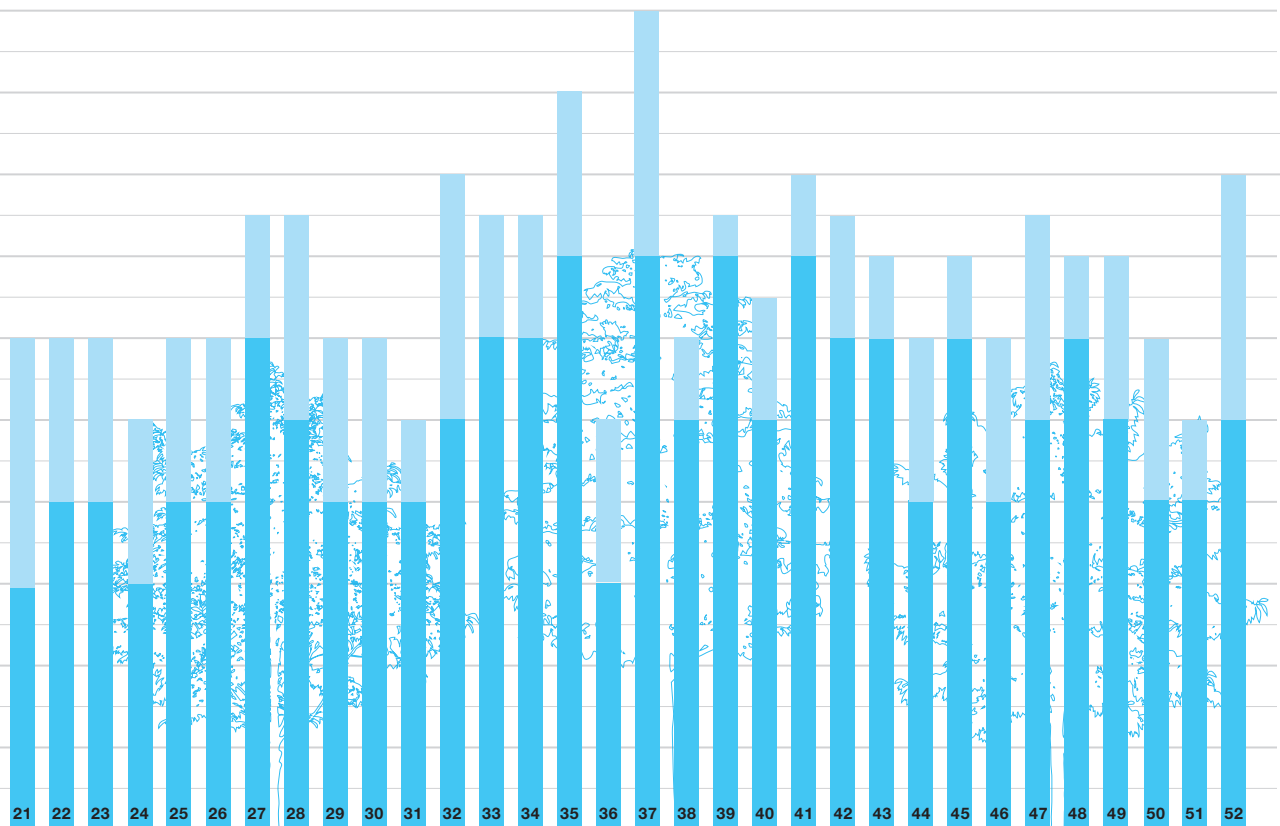

Tall Trees

	Scientific Name	Common Name	Height (Ft)
21	<i>Acer x freemanii</i> 'Jeffersred'	Freeman maple 'Autumn Blaze'	40-60
22	<i>Acer x freemanii</i> 'Marmo'	Freeman maple 'Marmo'	40-60
23	<i>Acer miyabei</i> 'morton'	Miyabe maple 'State Street'	30-50
24	<i>Acer rubrum</i>	Red Maple	40-60
25	<i>Acer rubrum</i> 'Columnaris'	Columnar Red Maple	40-60
26	<i>Aesculus hippocastanum</i>	Horsechestnut	50-75*
27	<i>Celtis occidentalis</i>	Common Hackberry	40-60
28	<i>Cerciphyllum japonicum</i>	Katsura Tree	40-60
29	<i>Corylus colurna</i>	Turkish Filbert (Hazelnut)	40-50
30	<i>Ginkgo biloba</i> (Male)	Ginkgo	50-80
31	<i>Gymnocladus dioicus</i>	Kentucky Coffeetree	60-75
32	<i>Liquidambar styraciflua</i>	Sweetgum	60-75
33	<i>Liriodendron tulipifera</i>	Tuliptree	70-90*
34	<i>Nyssa sylvatica</i>	Black Tupelo	30-50

	Scientific Name	Common Name	Height (Ft)
35	<i>Quercus bicolor</i>	Swamp White Oak	50-60
36	<i>Quercus coccinea</i>	Scarlet Oak	70-75
37	<i>Quercus imbricaria</i>	Shingle Oak	50-65
38	<i>Quercus macrocarpa</i>	Bur oak	70-80
39	<i>Quercus rubra</i>	Red Oak	60-75
40	<i>Quercus palustris</i>	Pin Oak	60-70
41	<i>Quercus phellos</i>	Willow Oak	40-60
42	<i>Quercus prinus</i>	Chestnut Oak	60-70
43	<i>Quercus shumardii</i>	Shumard Oak	40-60
44	<i>Sophora japonica</i> 'Regent'	Japanese Sophora	50-75
45	<i>Tilia cordata</i>	Little-Leaf Linden	60-70
46	<i>Tilia tomentosa</i>	Silver linden	50-70
47	<i>Ulmus americana</i> (disease resistant)	Elm	40-60
48	<i>Ulmus parvifolia</i>	Chinese Elm	40-50
49	<i>Zelkova serrata</i> 'Village Green'	Village Green Zelkova	50-80

* = Not a recommended street tree



Portland, Oregon



Vegetated Stormwater Management

- 70 Stormwater Planters
- 72 Rain Gardens

Given the economic, aesthetic, and health impacts of water pollution, compounded by climate change and more frequent and heavy rain, the City of Boston is working to identify new ways to manage stormwater more effectively. The most efficient and cost-effective way to do this is through small scale stormwater practices throughout the city to collect and manage stormwater where it falls. While the City of Boston's streets and sidewalks make up only about 15% of the total city area, they comprise over half of the land the city owns, making streets, alleys, and sidewalks obvious candidates for stormwater management practices.

Increasing urban vegetation will create more evapotranspiration—water sent into the air as vapor through either evaporation or transpiration from plants. This will both cool the air and reduce the overall volume of runoff that is generated by rainfall. While trees are the most effective form of vegetation for these processes, other vegetation can make a significant improvement over traditional hardscape. Areas of grasses, swales, rain gardens, and even small vegetated planters can be used to reduce the amount of paved surfaces and increase the overall vegetation in the city.

Important considerations when selecting the right type of vegetation include sight line requirements; the type of microclimate; tolerance to drought and inundation; resistance to insects and disease; resistance to vehicular emissions and salt; the ability to remediate pollutants; and the amount of maintenance required.

The systems described in the following sections are closely related to each other and should be customized for a specific location. Landscape architects and civil engineers must survey existing soil and drainage conditions, create an overall drainage and recharge plan, and specify the various components according to the opportunities and constraints for a particular project and location.

Accordingly, these guidelines provide basic descriptions of each type of system, where they can fit into Boston Street Types, and basic maintenance requirements, but exclude recommendations for specific configurations or construction details.

Stormwater Planters and Rain Gardens

Stormwater planters and rain gardens are designed to collect and treat runoff from the surrounding area. They rely on both physical and biological systems, using mulch, soil, plant root systems, and soil microbes to hold water and capture pollutants such as bacteria, nitrogen, phosphorus, heavy metals, oil, and grease. Stormwater planters generally have structural elements such as curbs, retaining walls, overflow pipes, and underdrains. Rain gardens tend to be simpler recessed planting beds. The fundamental design principles, however, are the same: soils are highly porous with a high organic content to support healthy plant communities. Planters and gardens that are adjacent to paved areas can include structural soil beds to increase their stormwater management capacity.

Stormwater planters and rain gardens are not designed to hold standing water for long periods of time and should drain down to a dry surface within 24 hours of a storm event. Plants should be selected that are tolerant of short periods of inundation, but can also survive long dry periods as they will generally not be irrigated. Plants should also be salt tolerant if runoff from streets or sidewalks will be captured. Planters and gardens can be lined if infiltration is not desirable or feasible, but lined planters must be designed to drain to an external structure. All planters and gardens should have overflow structures. Plant selection should be appropriate to the surrounding context, and should be sensitive to maintenance capacity.

Stormwater planters and rain gardens are considered enhanced treatments and require special maintenance agreements.

All vegetated stormwater management designs in the public right-of-way must be approved by the Boston Parks Department and PWD. They are considered enhanced treatments and require special maintenance agreements.

Stormwater Planters

Overview

Stormwater planters are cost-effective enclosed structures that can be modified to fit almost any physical constraint. They can be used in medians and added to the Greenscape/Furnishing or Frontage Zones of sidewalks. Stormwater planters may also be used as traffic calming devices on curb extensions or designed as chicanes. They can be designed for trees or low vegetation depending on size and visibility constraints.

Stormwater planters are usually designed to capture runoff from surrounding paved surfaces, including rooftops, sidewalks, plazas, parking lots, and streets. They generally have structural walls and curbs, underdrains to keep water

from building up in the soil, and an overflow pipe to control excess flow and prevent flooding onto adjacent areas. Drains and overflows are usually connected into nearby stormdrains. They usually have open bottoms to allow for infiltration. Generally, a planter is composed of the following layers: mulch, plants, specific soil mixture, infiltration bed, and the native soil. Engineered geotextile lining material may be used in some applications, but is generally not desired on the bottom of the planter as it can easily clog.

Stormwater planters are considered an enhanced treatment and require a special maintenance agreement.

2 SIDEWALKS

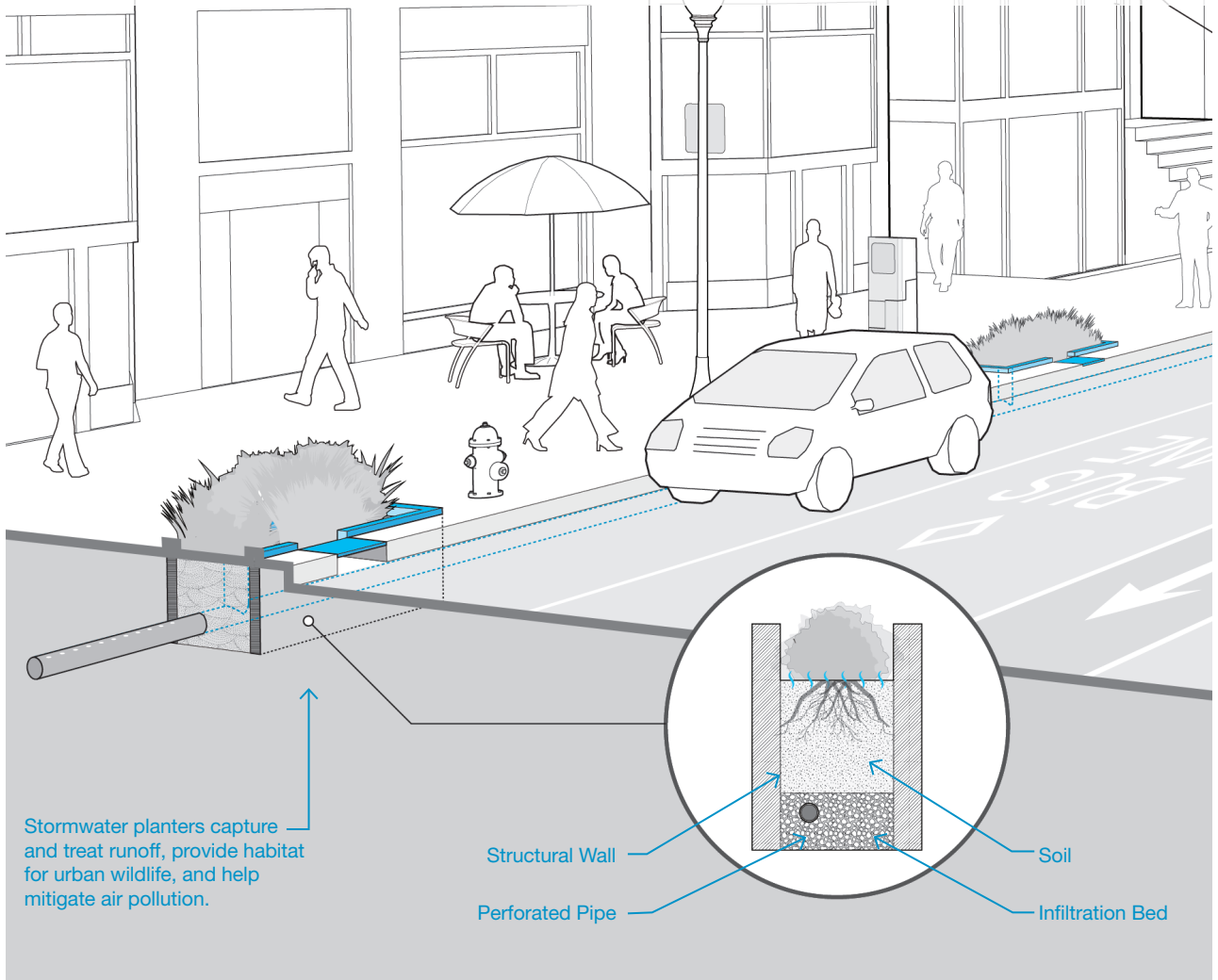

Use

- ▶ Stormwater planters can contain a wide variety of plant types, including simple grasses, perennials, shrubs, and, if there is sufficient rooting space, small trees.
- ▶ Planters can be placed along sidewalks behind the curbline. They can also be placed inside curb extensions and in pedestrian plazas.
- ▶ Planters should be designed with curbs and inlets to withstand snow plows and street sweepers, and to provide access to parking and other site-specific needs.
- ▶ Runoff from rooftops, sidewalks, and pedestrian plazas can be directed into planters without pretreatment. Runoff from streets and parking lots should receive some pretreatment such as flowing through a sump or a sediment capture area.
- ▶ Planters can line an entire block as long as breaks are provided where on-street parking exists.
- ▶ Planters can be used adjacent to buildings, but generally waterproofing is desirable to prevent flooding into basements and foundations.
- ▶ Planters can be combined with seat walls to provide seating.

Maintenance requirements can include:

- ▶ Removal of sediment, litter, and debris as needed
- ▶ Clean out of sumps or pretreatment areas once or twice per year
- ▶ Annual weeding and replacement of dead plant material
- ▶ Occasional mulch and top soil replacement
- ▶ Aeration and/or replacement of soils if clogging or standing water are observed for more than 24 hours after rain
- ▶ Inspection of inflow and overflow points, and other structural components after large rain events
- ▶ Spring cleaning if area is used for snow storage

Considerations

- ▶ Subsurface installation must account for utilities and “areaways.”
- ▶ Designs must consider providing connections to traditional drainage systems.



Rain Gardens

Overview

Rain gardens function like stormwater planters but generally have fewer structural elements. They may appear more like conventional landscaped areas but are depressed rather than elevated from the surrounding area. They can be used in areas where a more natural garden aesthetic is desired. They are commonly used in residential areas and urban settings with ample space, as rain gardens are often larger providing opportunities for more diversity in plant life over planters.

Vegetated swales are linear rain gardens that convey runoff to a desired location and can be used to augment traditional pipe and gutter systems. Vegetated swales slow runoff velocity, filter stormwater pollutants, reduce runoff temperatures, and in low volume conditions recharge groundwater.

Green gutters are narrow vegetated swales constructed in the Greenscape/Furnishing or in the Frontage Zone to capture, infiltrate, and convey runoff from the adjacent sidewalk. Sidewalks should be pitched to convey runoff into swales or green gutters.

Filter strips are rain gardens that capture sheet flow from a parking lot or other paved area. During smaller rain events, runoff is absorbed in the filter strip. For larger events, the runoff is partially absorbed and filtered before it flows to an infiltration trench or other system.

In addition to the other benefits of vegetated stormwater management, these systems are capable of:

- ▶ Enhancing the aesthetic appeal of streets, neighborhoods, and commercial or industrial sites
- ▶ Providing wildlife habitats
- ▶ Reducing soil erosion
- ▶ Providing locations for snow storage

Rain gardens are considered an enhanced treatment and require special maintenance agreements.

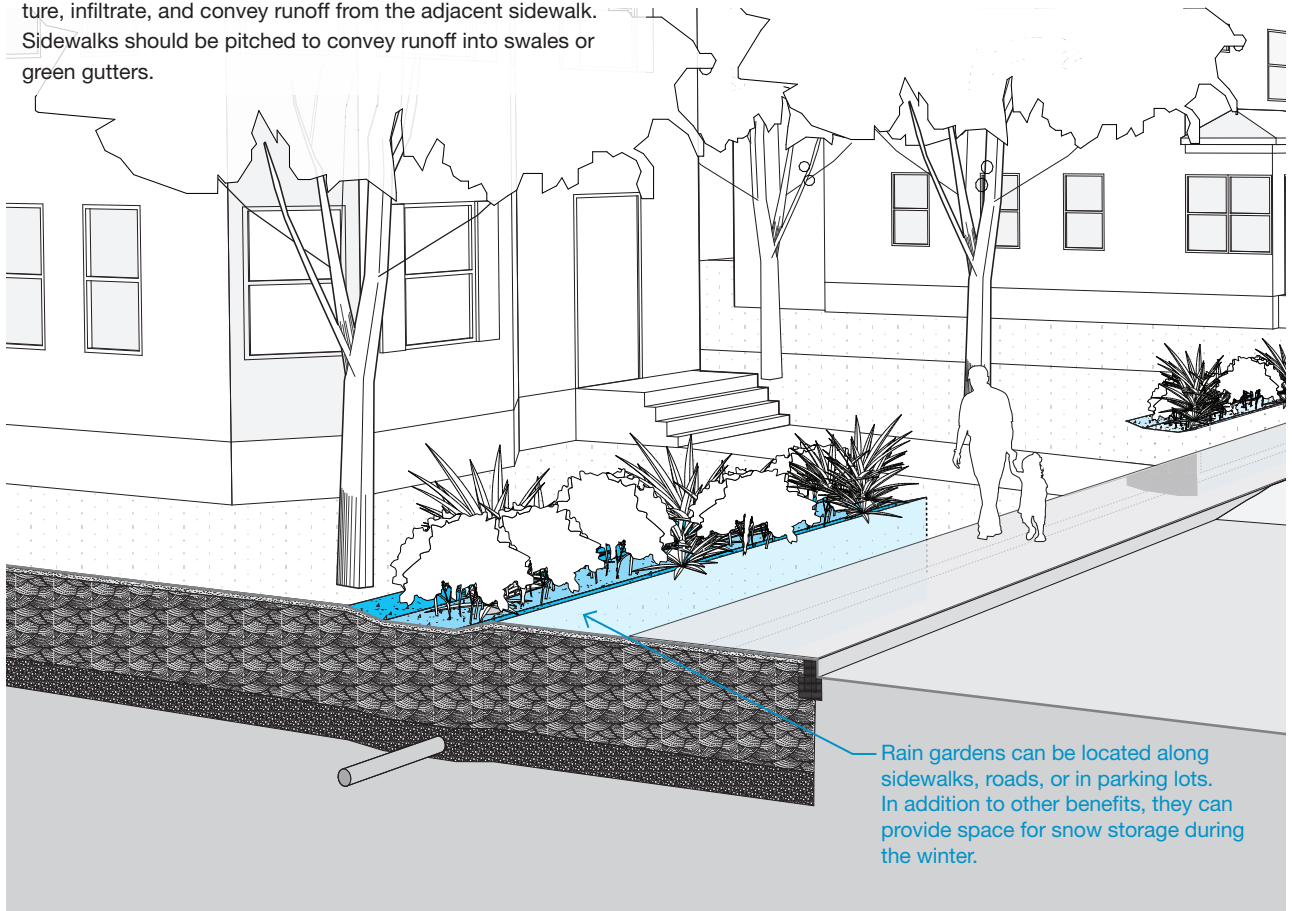

Use

- ▶ Rain gardens are typically located along sidewalks, roads, or surface parking lots. They require engineered soils to permit stormwater to permeate and dense vegetative cover to prevent erosion. Grasses are the most common plants used in rain gardens and vegetated swales.
- ▶ Filter strips are typically used along parking lot aisle and edges.

Maintenance requirements can include:

- ▶ Removal of sediments, litter, and debris as needed
- ▶ Identification of eroded areas for stabilization
- ▶ Watering during dry periods
- ▶ Annual weeding and replacement of dead plant material
- ▶ Occasional replacement of mulch and top soil as needed
- ▶ Deep tilling and/or replacement of soils if clogging or standing water are observed more than for 24 hours after rain events

Considerations

- ▶ Where space is limited, green gutters should be considered.
- ▶ Where slopes exceed 5%, rain gardens should be terraced or include check dams to prevent erosion.
- ▶ Plants should be selected to address site specific conditions such as amount of salt and pollutants, maintenance capacity, and aesthetic context.





Street Furniture

- 76 Seating
- 78 Bollards
- 79 Trash Compactors and Recycling Bins
- 80 Bicycle Parking
- 81 Bicycle Racks

Well-designed street furniture makes the sidewalk more comfortable and life on the sidewalk more convenient. Benches provide places to rest, catch up with neighbors, or have lunch. Properly distributed trash receptacles help to keep the street clean. Appropriately located bicycle racks and shelters are essential to encouraging people to ride by making parking more convenient, and helps support bicycling as a viable mode of transportation. In addition to providing amenities, street furniture can also provide a buffer from the noise and commotion of vehicles on the street.

Street furniture that is not thoughtfully laid out can obstruct and clutter the sidewalk environment. This section provides design guidelines for street furniture in the sidewalk, including bicycle parking, seating, and waste receptacles. Street furniture is normally installed in the Greenscape/Furnishing Zone, although it can also be installed in the Frontage Zone and on curb extensions. Street furniture should not be installed in or protrude into the Pedestrian Zone.

Boston's street furniture must be organized in a way that maximizes safety, comfort, and function for all users. The design of street furniture should be simple and compatible with the existing built environment.

In addition to furniture, the layout of sidewalk elements such as sign and light poles, utility covers, hydrants, traffic control devices, and parking meters should seek to maximize safety, comfort, and function. These essential roadside components must be thoughtfully laid out to maximize accessibility and functionality. Signs should be consolidated (based on size) to one pole or light post to reduce clutter and maximize visibility. Smart meters should be centrally located. Hydrant locations should minimize conflicts with motor vehicles. Traffic control devices should not be placed on curb ramps and must maximize visibility for the appropriate roadway user. Utilities and "areaways" should be clear of obstructions and accessible for maintenance. In addition, the layout of the Greenscape/Furnishing Zone should function to store snow and consider which furnishings and elements must remain accessible during winter months. Interagency coordination is required in order to achieve these goals.

Boston's Coordinated Street Furniture Program

Boston's streetscape is being transformed by the City's Coordinated Street Furniture program. Implemented by the Property and Construction Management Department, the 20-year program includes over 400 elements on streets throughout the city, providing amenities for residents and visitors alike. The program exists at no cost to the City of Boston. The first coordinated program in the nation, it consists of a series of architecturally matching elements including bus shelters, city information panels, telephone pillars, and automatic public toilets. The installation of any of these elements must be coordinated with the City's program.

Note: In order to maintain consistent appearance within historic districts, fixture design, color, and materials must be approved by local Historic District Commissions.

Seating

Overview

Providing a place to sit is a basic necessity. Seating gives pedestrians a place to rest, wait, or simply to relax and enjoy street life. Providing comfortable, inviting places to sit can transform a sidewalk into a gathering place and enhance its role as a public space and community amenity. Seating should encourage lingering, as longer stays produce livelier sidewalks.





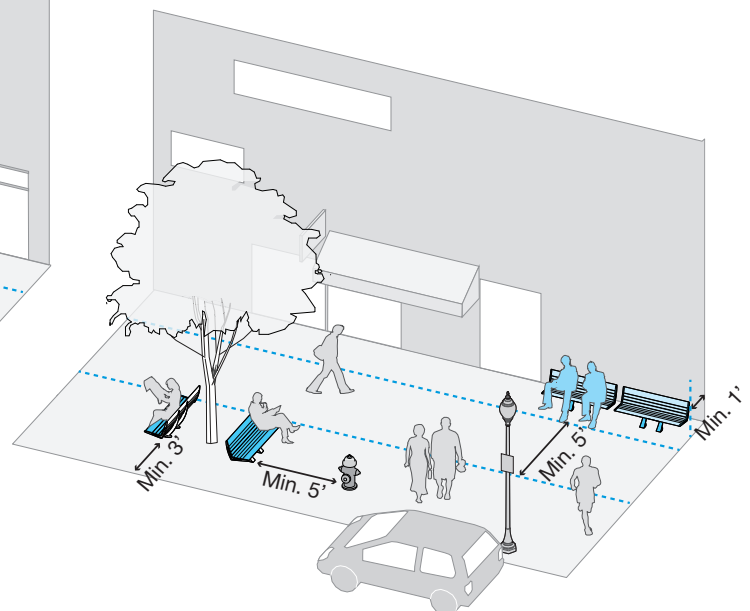
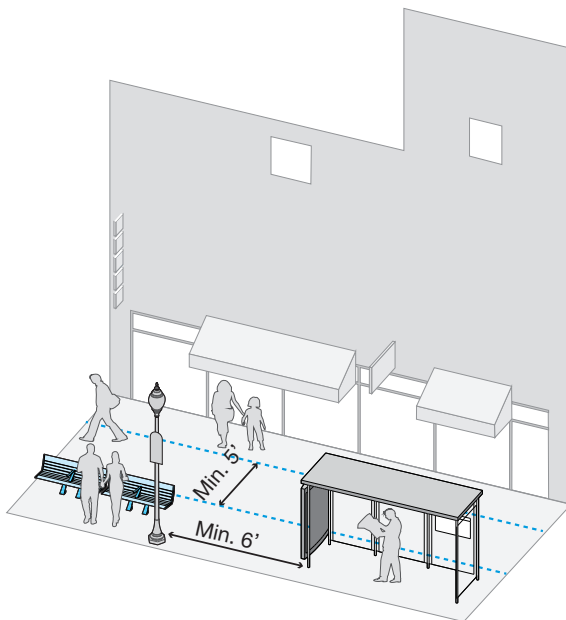

Use

Seating comes in a variety of temporary and permanent forms, such as chairs, benches, seating walls, steps, monuments, planters, raised tree beds, etc. People enjoy watching others move about; the design and location of seating should respond to how the surrounding space is used. The best location for seating is a protected location (away from typical pedestrian flows, beneath a street tree) outside the Pedestrian Zone, with views of people walking by.

- ▶ Care should be exercised to ensure that permanently installed seating does not interfere with entrances to buildings, loading zones, parked vehicles, access to fire hydrants, and other potential conflicts.
- ▶ Seating should be provided for a minimum of two people. Single seats may be provided as long as they are in groups of 2 or more. Seating can be integrated into buildings, raised tree beds, planters, and street walls. Street cafés and temporary seating are covered earlier in this chapter.
- ▶ Benches adjacent to bus stops should ideally be located at the back of the sidewalk and face the street. They should also be located to the right of and outside of the front door landing zone and outside of the Pedestrian Zone.



The following ADA clear widths must be maintained when installing benches:

- ▶  **3' minimum** on either side of the bench (except beside an ad panel of a bus shelter, where 6' clear width is required to open the panel door)
- ▶  **5' minimum** from fire hydrants
- ▶  **1' minimum** from any other amenity, utility, or fixture
- ▶  **5' minimum, ideally 6'** clear path to provide an additional 1' for people's legs, in front of the bench when located at the back of the sidewalk, facing the curb
- ▶ Where the back of the bench abuts a building, wall, or other obstruction, a  **1' minimum clear width** should be provided for maintenance and trash removal
- ▶  **5' minimum** clear path must be provided behind a bench when located at the front of the sidewalk facing the curb

Considerations

- ▶ Seating should be provided both with and without armrests if possible. Armrests provide stability for those who require assistance sitting and standing. Seating without armrests allows a person in a wheelchair to maneuver adjacent to seating or to slide onto it easily. Seating areas **longer than**  **4'** should provide armrests or other dividers to discourage reclining.
- ▶ While movable seating provides flexibility to arrange the space as desired, public seating on the sidewalk should be affixed to the sidewalk unless a responsible party agrees formally to be responsible for locking it up at night and replacing it if necessary.

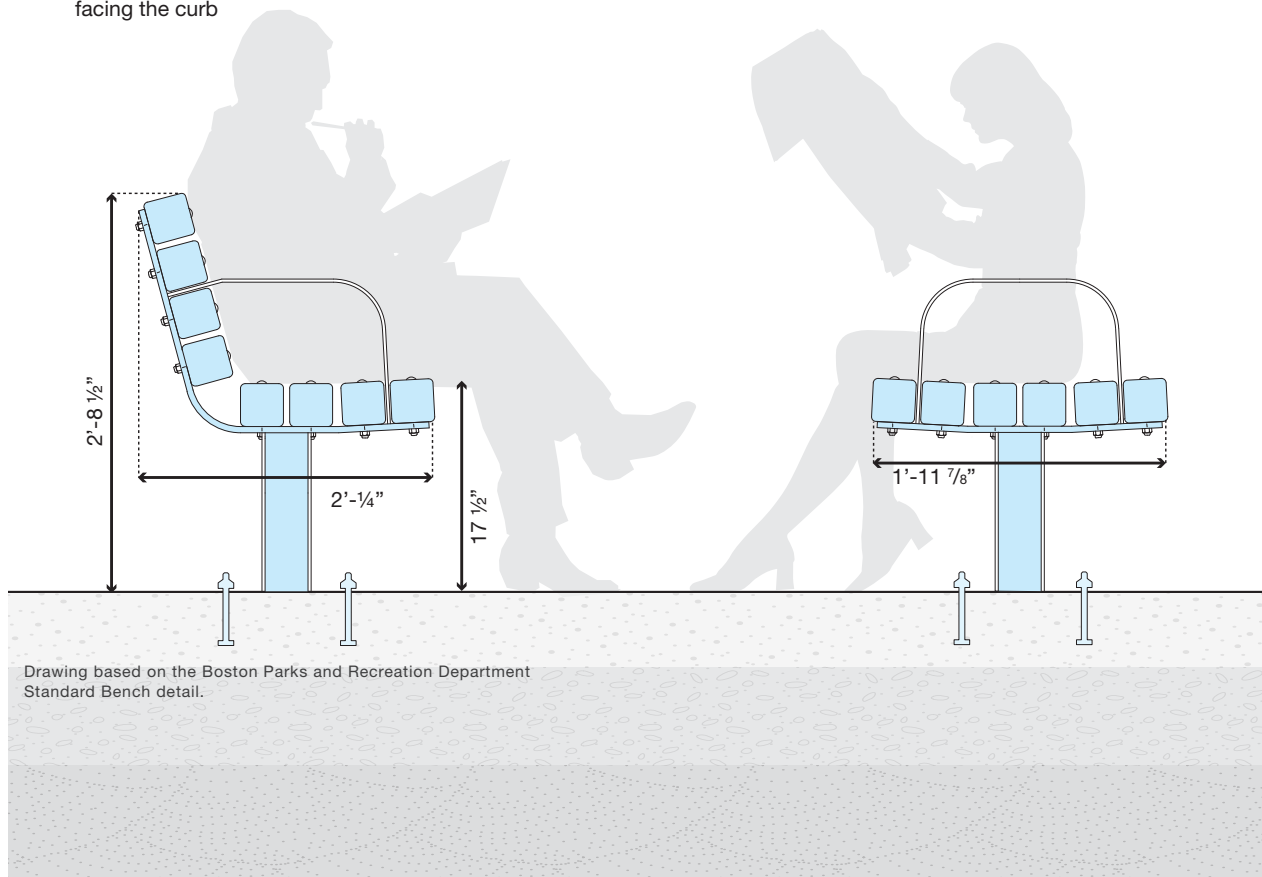

Bollards

Overview

Bollards are permanent or temporary posts or objects used to create an unobtrusive boundary between different modes of transportation or different realms of the street. Bollards function to protect pedestrians, bicyclists, buildings, and specific areas from vehicular access and to highlight traffic calming measures. The abundance of pedestrianized streets and plazas embedded in Boston's centuries-old fabric makes bollards a critical element of the streetscape.

Bollards can be fixed, flexible, or movable. They can be designed to withstand heavy impacts, or give way on impact. Movable and breakaway bollards are intended to deter vehicle access, but allow entry for fire engines and ambulances in case of an emergency. Bollards come in all shapes and sizes, from standard posts to stormwater planters.

Use

The most important design feature when using bollards is visibility. Bollards must be clearly visible in all lighting conditions for all users, particularly pedestrians and motor vehicles. Reflective material, lighting, and colors that provide contrast to the surrounding environment should be used. Proper size and spacing should balance restricting vehicular access with providing an unobstructed path for pedestrians. There are a number of different bollards used in the city, with the standard 4" diameter black bollard being most commonly used. In addition to standard bollards, there are a number of styles that are used to distinguish the character of certain Historic Districts and some specially designated redevelopment areas.

Bollards can be used to:

- ▶ Restrict vehicular access to car-free zones, trails, cycle-tracks, waterfronts, etc.
- ▶ Prevent delivery trucks from using sidewalks in commercial and mixed-use areas
- ▶ Provide security measures for buildings and infrastructure such as government and financial institutions
- ▶ Reduce turning radii to decrease vehicular speeds around corners
- ▶ Create protected space for street furniture
- ▶ Protect stormwater management features such as rain gardens, stormwater planters, and green curb extensions
- ▶ Direct traffic flow and highlight traffic calming measures such as chicanes on Shared Streets

Considerations

- ▶ Bollards require proper maintenance when damaged due to accidents or deterioration from the environment. If not maintained, they can become tripping hazards and may leave sharp edges exposed.
- ▶ Movable bollards should be considered if restricting access is only needed during part of the day, but they can be more costly.
- ▶ Bollards can provide other amenities such as bicycle parking, lighting, power outlets, litter and recycling receptacles, and art.

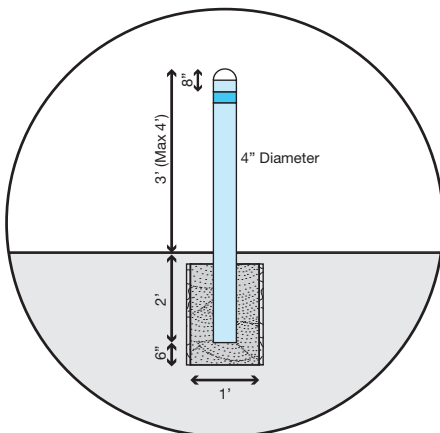

Trash Compactors and Recycling Bins

Solar Powered Trash Compactors

In 2006, the City began installing solar powered trash compactors. These smart receptacles increase capacity, prevent trash from being blown (or taken by birds) onto the sidewalk, and discourage the disposal of household trash in sidewalk barrels. As the number of receptacles increase, it is possible to lower operational costs by reducing the number of pick-ups, particularly in locations traditionally requiring multiple pick-ups per day.

The minimum sidewalk width required to accommodate trash receptacles is **7'-6"**. The following minimum setbacks must be maintained:

- ▶ **18"** surrounding the receptacle
- ▶ **5'** from fire hydrants
- ▶ **1'** from any in ground obstruction (manhole, tree pit etc.)
- ▶ **3'** from other street furniture
- ▶ **5'** clear Pedestrian Zone adjacent to the receptacle

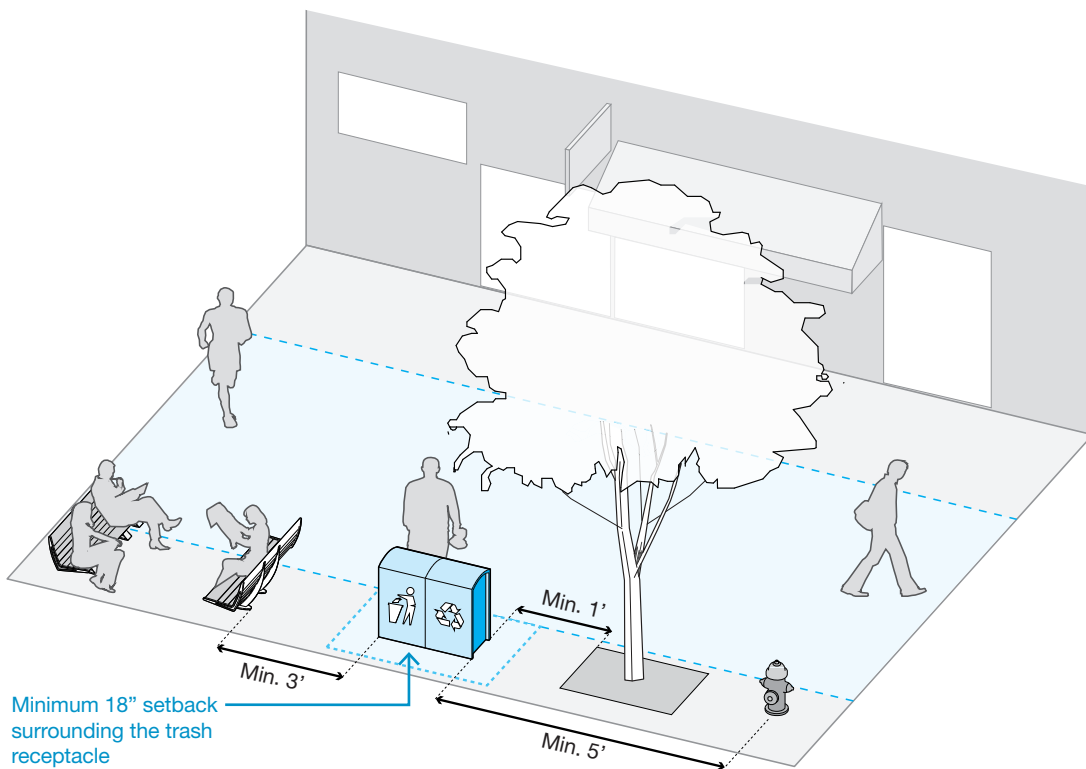

In 2012, the inventory of trash compactors reached about 600 units, with a concentration in the highest volume areas of the city. Additionally, the units will be equipped with Wi-Fi to report operational status and remaining capacity. Solar receptacles should be considered the standard for new locations, major sidewalk reconstruction, and plazas. Because of their higher capacity, fewer receptacles are necessary in high volume locations. Institutions and new developments are encouraged to provide solar compactors as part of streetscape standards.

Recycling Bins

In 2011 the City began a pilot of installing recycling bins attached to the solar compactors. At no cost to the city, 400 new solar-powered trash and recycling receptacles are currently being installed over the next year. The bins feature wireless internet, allowing city workers to check the status of an individual receptacle, helping reduce labor costs to empty bins.

Bicycle Parking

Due to the small footprint of a bicycle—the typical parked bicycle is  **6' long by 2' wide**—bicycling is particularly well-suited for a congested city like Boston where space for parking is at a premium. Providing ample, well-designed bicycle parking is a key component of the City's strategy to increase bicycling. Bicycle parking consists of a rack that supports the bicycle upright and provides a secure place to lock. Bicycle racks should be permanently affixed to a paved surface; movable bicycle racks are only appropriate for temporary use.

Bicycle parking is required in most types of new construction and redevelopment. Long-term (overnight) bicycle parking for residents, employees, and students should be provided within buildings. Short-term bicycle parking should normally be provided on the sidewalk or in plazas close to building entrances.

Bicycle parking is installed through Boston Bikes, the City's comprehensive program to encourage bicycling, and requires approval from PIC. Over 1,500 racks have been installed from 2008 to 2011, with additional racks being installed throughout the city. While most racks were installed based on surveys of need, residents and businesses can request that the City install racks on public sidewalks near their properties.

The specific amount and type of bicycle parking required for new developments is outlined in the City of Boston's Bicycle Parking Guidelines. Visit the Boston Bikes website for more information on bicycle rack requirements and how to request the installation of a bicycle rack.

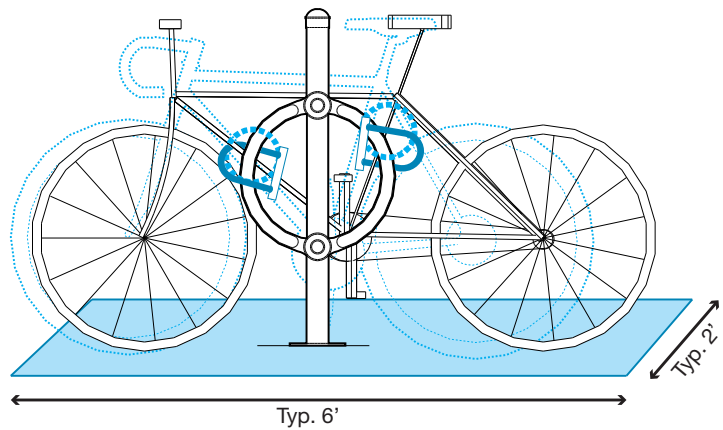

Bicycle Racks

Overview

Bicycle racks are essential to making bicycle parking more accessible and bicycling a viable form of transportation. Good bicycle parking designs are permanently fixed to the ground, maximize capacity, maintain an orderly appearance, are secure, and are simple to use.

Use

The City of Boston's Bicycle Parking Guidelines require bicycle racks to be installed as part of street reconstruction projects on non-residential streets. The highlighted dimensions are from the City's Bicycle Parking Guidelines, which should be referenced for a complete list of rack placement setbacks and requirements. Overall, it is most important that racks are not installed so parked bicycles obstruct the Pedestrian Zone or access to fire hydrants.

Bicycle rack designs must meet the following criteria:

- ▶ Support the frame of the bicycle at two points above the bicycle's center of gravity
- ▶ Provide access for different bicycle frame sizes and styles
- ▶ Allow easy locking of the frame and at least one but preferably both wheels
- ▶ Be easily accessible while meeting all minimum setbacks

Considerations

- ▶ Where there is room, bicycles should be parked in clusters at a 45 degree angle in the Greenscape/Furnishing Zone or Frontage Zone **1**.
- ▶ In streetscape projects, bicycle racks should be located in proximity to street trees to discourage the use of trees for bicycle parking.
- ▶ Property owners are encouraged to install bicycle racks on sidewalks. Applications are available on the City website. Requests to install bicycle racks on the public right-of-way must include a plan demonstrating compliance with the City's Bicycle Parking and Complete Street Guidelines.
- ▶ On-street bicycle parking should be considered where there are space constraints on the sidewalk. Eight to ten bicycles may be parked in one motor vehicle space. For more information, see Chapter 5: Smart Curbsides, On-Street Bicycle Parking.

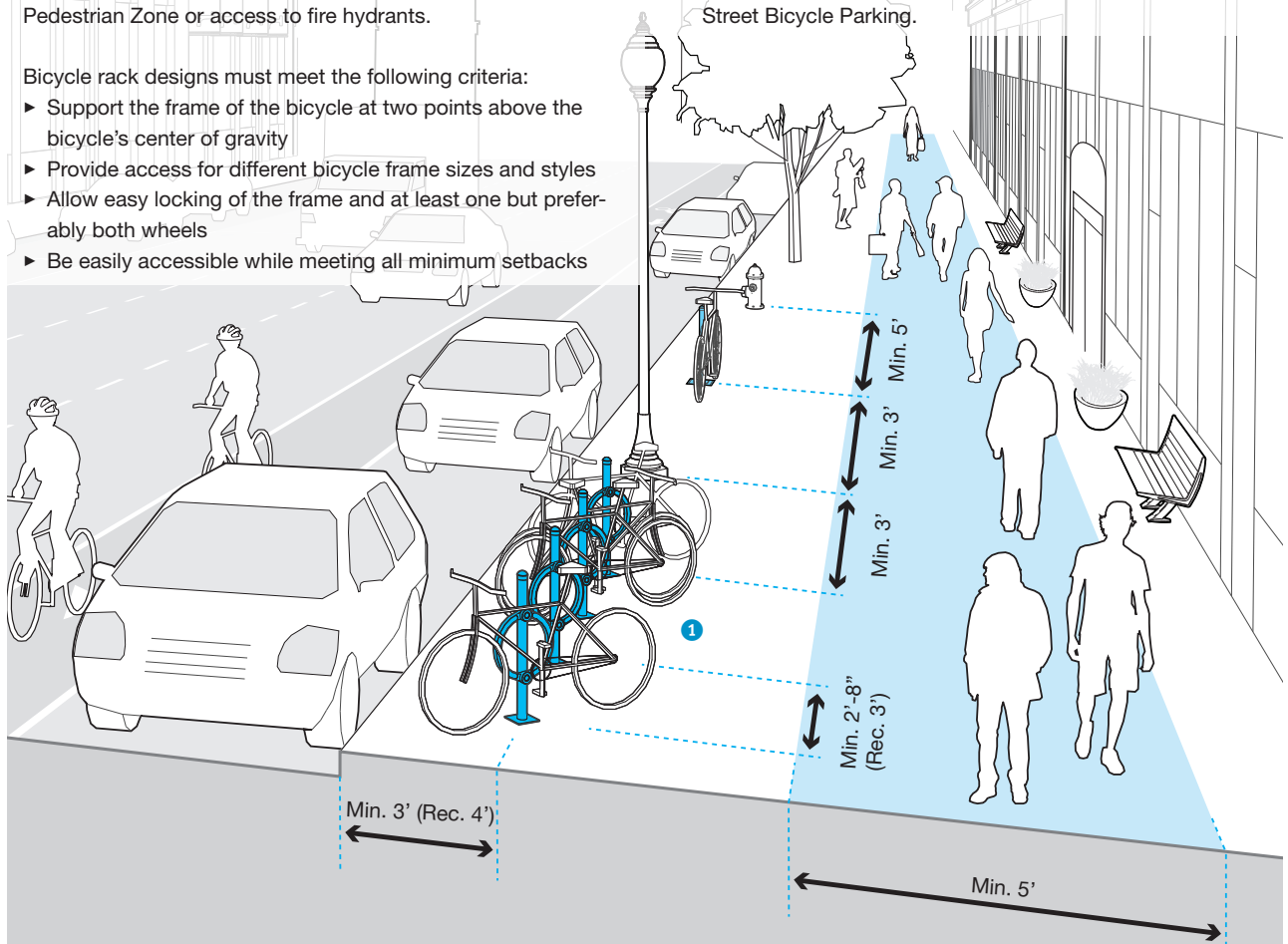

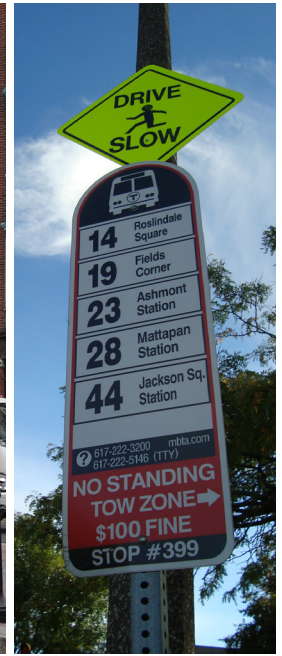

Transit Stops

- 84 Bus Stops
- 86 Bus Shelters

Sidewalks are essential pieces of infrastructure for the safety, convenience, and accessibility of transit riders. Sidewalks provide space for passengers to wait at bus stops, and accommodate shelters and other transit stop amenities. Transit stop amenities improve operations, ridership, and the value of transit to the community. Amenities can include shelters, benches, trash, recycling receptacles, lighting, street trees and vegetated stormwater management, bicycle racks, newspaper boxes, and public art. Personalizing transit stops gives the community a sense of ownership and pride.

Travel information for riders is also an important amenity at transit stops; at a minimum this should include route and schedule information, and ideally will include real-time arrival information where possible. Transit stops can also be locations for local area maps and wayfinding information.

All transit stops should be fully ADA accessible for passengers. Transit stops extend from the Pedestrian Zone to the curb and should provide ample room for transit riders to assemble without crowding the pedestrian clear path. Transit stops may also be located on curb extensions and floating islands where on-street parking is present.

Of the Massachusetts Bay Transit Authority’s (MBTA) 350,000 average weekday bus passengers, a majority board at stops and shelters located on Boston’s streets. The MBTA’s busiest transit routes ply through Dorchester, Roxbury, Mattapan, Jamaica Plain, Allston/Brighton, and the South End. While many stops are demarcated only by “tombstone” signs, several hundred transit shelters have also been installed through Boston’s Coordinated Street Furniture program. Where space and ridership permit, shelters should be added to bus stops to make them more comfortable and convenient.

The installation of transit stop amenities should be done in consultation with the MBTA, BTD, PWD, and PIC. The MBTA’s Bus Stop Planning and Design Guidelines serve as the primary reference for the design, spacing, and location of transit stops in Boston. These guidelines focus on transit stops on sidewalks, and do not cover the design of subway stations or light rail stops; for subway and light rail designs coordination with PWD, BTD, PIC, and the MBTA is required. As the preferred location of transit stops is typically adjacent to intersections rather than mid-block, transit stop siting and spacing is covered in Chapter 4: Intersections.

Bus Stops

Overview

Bus stops are the most basic transit stops, and should be comfortable, safe, and accessible. They must accommodate the standard 40' bus, or the articulated 60' bus on select busier routes. Stops should be visible, providing a clear sightline between bus operators and users of the system. Simple stops without shelters may be appropriate where sidewalks are narrow along lower volume routes and on Neighborhood Residential and Industrial Street Types.

The area on the sidewalk where passengers load and unload at bus doors is called the landing zone (also known as the landing pad), which should be free from all obstructions including sign posts and bus stop amenities. The landing zone is a part of the existing sidewalk that is essentially an extension of the Pedestrian Zone to the curb at bus stops so that passengers may access the sidewalk directly from bus doors. Space should be provided for snow storage during winter months in order to maintain clear and accessible landing zones.

- ▶ The length of the stop depends on vehicle type as well as the location of the stop, (i.e., near-side, far-side, or mid-block) and should be done in consultation with the MBTA. In general, far-side, near-side, and mid-block stops should be **at minimum 60', 90', and 100'** in length respectively. Along routes serving articulated buses, far-side, near-side, and mid-block stops should be **at minimum 80', 100', and 120'** respectively. For minimum and preferred bus stop lengths, see the detailed chart in Chapter 4: Intersections, Bus Stop Location.
- ▶ Trees should not be planted within landing zones of a bus stop; these may vary depending on the type of bus used. When street trees are desired near or within bus stops, the MBTA must be consulted. Trees require a minimum offset of **10'** from landing zones.

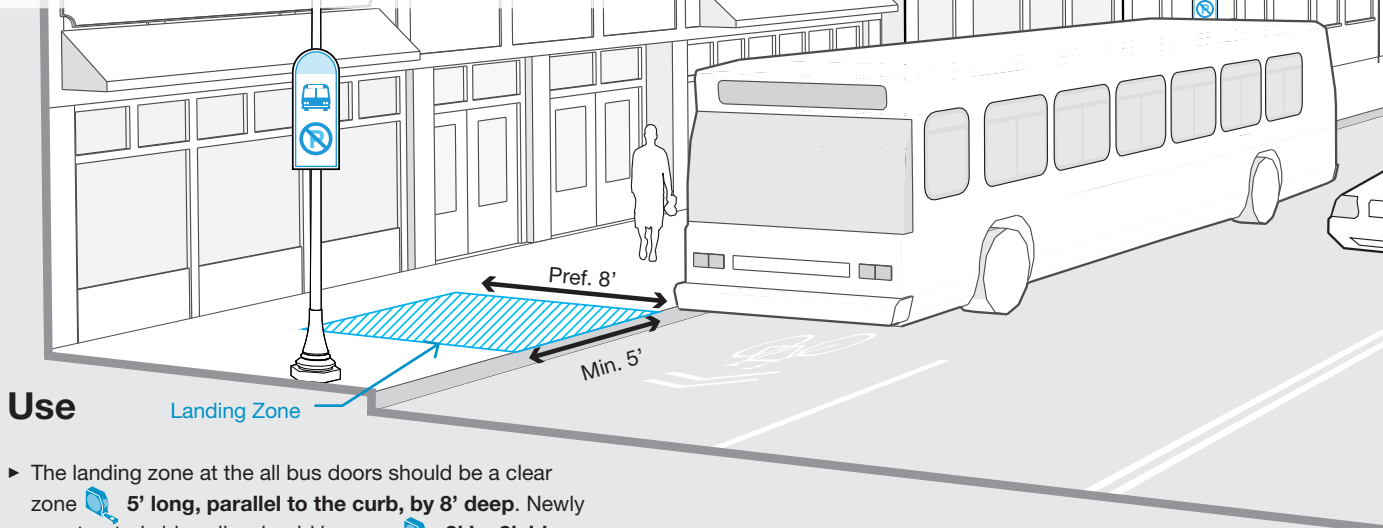

Use

- ▶ The landing zone at the all bus doors should be a clear zone **5' long, parallel to the curb, by 8' deep**. Newly constructed sidewalks should have an **8' by 8', ideally 10' by 8' landing zone** to provide an accessible space for loading and unloading. If the sidewalk is not wide enough to support an 8' landing zone, a curb extension should be built where on-street parking is present to accommodate the minimum width.
- ▶ Landing zones should be provided at all doors of the bus. For articulated buses, the **distance between the front and rear landing zones is 18'**. Different length buses have different door configurations, and landing zones should be designed in coordination with the MBTA.
- ▶ Bus stops should be setback a minimum of **5'** from crosswalks. Where feasible, a **10'** setback is preferred.
- ▶ Where possible, trash and recycling receptacles should be placed near the front of the bus stop, **at a minimum of 18' to the left of landing zones, minimum 3' away from benches**, and in the shade where possible. They should also be anchored to the pavement to deter theft.

Considerations

Curb extensions at bus stops, also called bus bulbs, can provide additional pedestrian space and improve bus travel time by reducing the time needed for loading and unloading. The depth of the curb extension is typically 6', and the minimum length should allow passengers to board and exit at all bus doors.

- ▶ Extensions are generally utilized at near-side bus stops; however they are not compatible with intersections that have high right-hand turn volumes.
- ▶ Curb extensions must consider bicycle lane placement.
- ▶ Bollards may be placed at the beginning of curb extensions to protect the pedestrian space.

Bus bays are a protected bus stop area with curb extensions at the beginning and end of the bus stop. Bus bays are generally not favored because they tend to procure further delay when re-entering into traffic, and are better suited for slower speed environments. On higher speed roadways, bus bays do provide more separation for pedestrians boarding and exiting the bus, but will require more space for deceleration and acceleration.

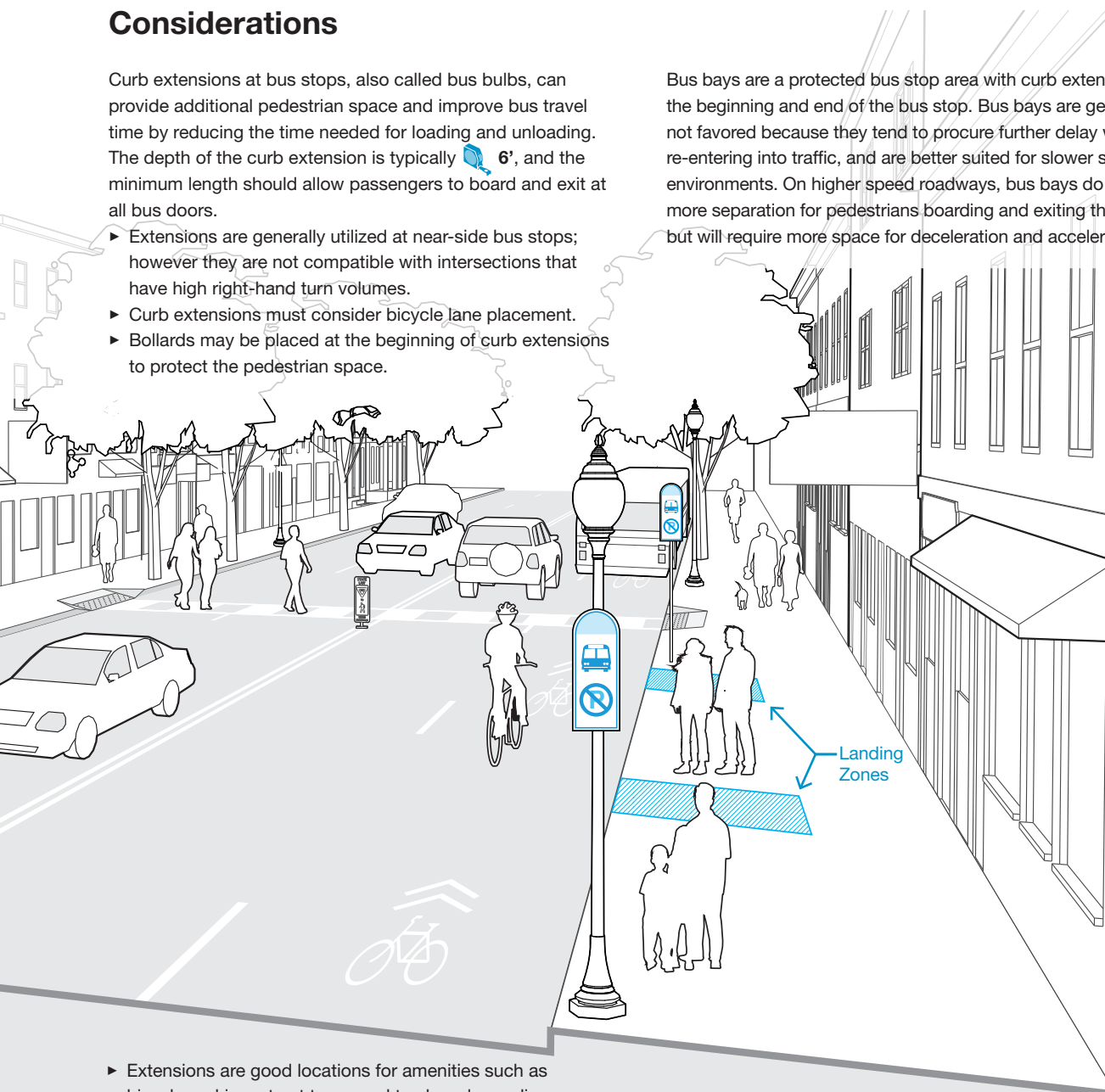

- ▶ Extensions are good locations for amenities such as bicycle parking, street trees, and trash and recycling receptacles, so long as the requirements for waiting area, clear path, and the landing zone are met.
- ▶ During the winter, curb extensions also provide valuable space for snow storage at bus stops.
- ▶ For more information on curb extensions at bus stops, see Chapter 4: Intersections, Bus Bulbs.

Bus Shelters



Overview

Well-designed transit stops can help make transit more comfortable and convenient. Bus shelters should be provided on all Key Bus Routes, the 15 busiest bus routes designated by the MBTA, if sidewalk space allows. When providing a bus shelter, an ADA compliant, 5' long (parallel to the curb) by 8' deep landing zone should be provided at all bus doors. Space should be provided for snow storage during winter months in order to maintain clear and accessible landing zones.

Shelter placement must allow for unobstructed loading and unloading. Shelters must provide at a minimum the stop ID, route information, name of shelter's owner, telephone number for maintenance, protection from the weather, seating or leaning bars. Bus shelters should have a name that incorporates a local landmark displayed on the panel facing the street.

All bus shelter installation must be approved by the City of Boston's Coordinated Street Furniture Program.

Use

The City of Boston provides two types of shelters: standard and ship-shaped. The standard shelter has three sides and is  **5' wide**, but can be modified to be two-sided. The **ship-shaped shelter is**  **4' wide** and is one continuous oval shaped piece.



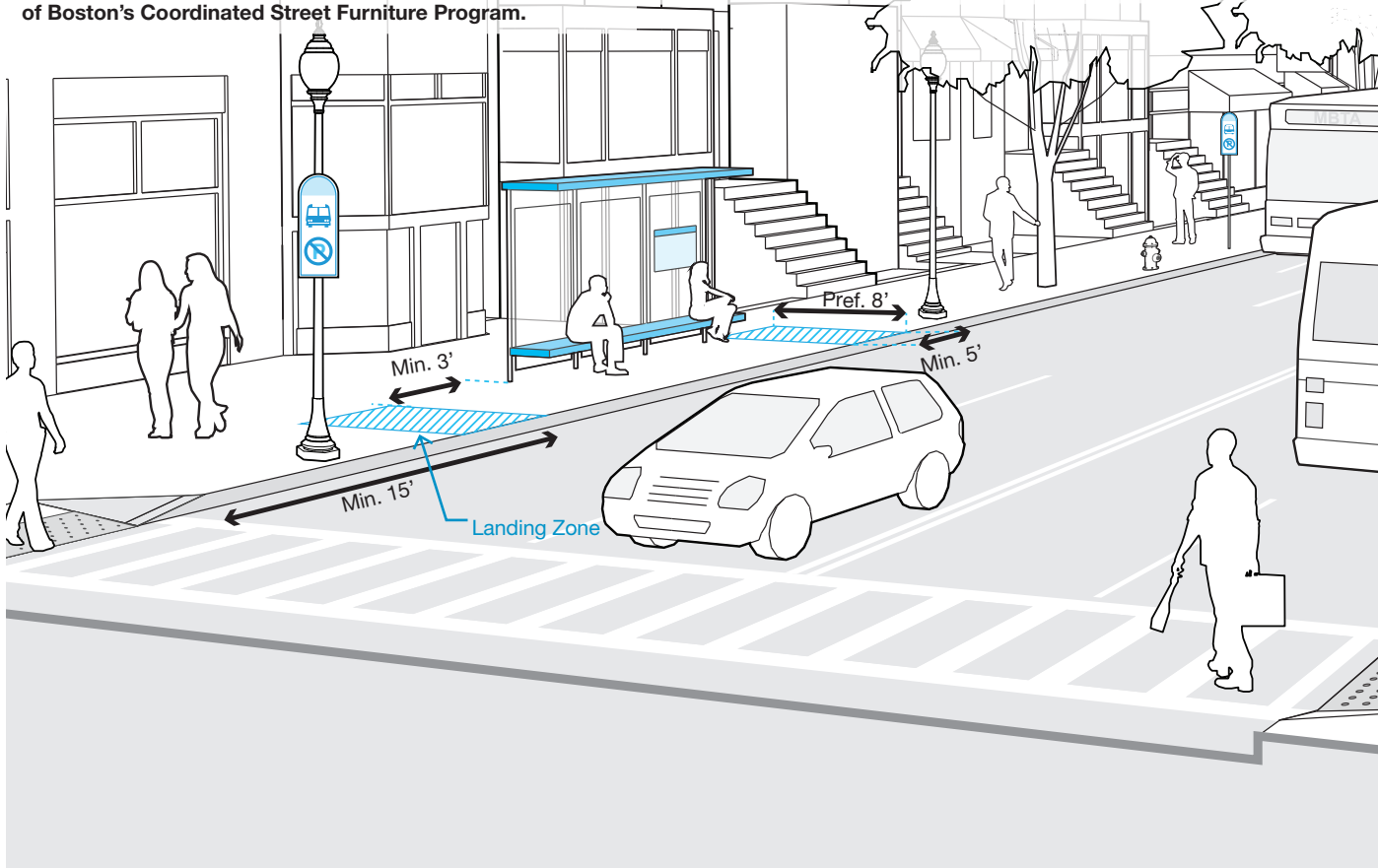



The siting of shelters is determined on a site-by-site basis. The MBTA's Bus Stop Planning and Design Guidelines provide criteria to help determine which stops are eligible for shelters. Factors for shelter installation include the amount of weekday daily boardings, Key Bus Route designation; senior, disabled, medical or social services; key municipal facilities close to the stop; community recommendations; bus route transfer points; infrequent service; poor side conditions; or if the shelter promotes adjacent development/increased ridership. After eligibility is determined, a site suitability test must be conducted.



The following requirements must be met before a shelter can be considered:



- ▶ Property ownership
- ▶ Abutter approval
- ▶ Compliance with accessibility requirements
- ▶ Adequate physical space and clear widths
- ▶ Close proximity to an existing bus stop
- ▶ Approval and maintenance agreements by the City of Boston

The following minimum clear widths for shelter placement must be maintained:

- ▶  **1'** from a blank building face (shelters should not block active store windows)
- ▶  **4'** from the back of curb
- ▶  **15'** from crosswalks for visibility at near-side bus stops
- ▶  **1'** from any ground obstruction (i.e., manhole, tree pit, sign post, etc.)
- ▶  **10'** from fire hydrants
- ▶  **3'** to the right of the landing zone (**maximum**  **25'** to the right of the landing zone)

Considerations

The location of transit shelters should minimize obstructions of sight lines. Curb extensions can be combined with transit shelters to alleviate sight obstructions. Shelters should be located between store entrances or shop windows wherever possible. Transparent materials such as glass help eliminate sight obstructions and improve security.

Shelters can be placed  **6'** from the building face where sidewalks are  **15'** wide or greater in order to provide an accessible path behind the shelter.

Shelters can provide more than just protection from inclement weather and a place to rest:

- ▶ Smart shelters can provide real-time travel information or other news.
- ▶ Shelters are a good location to incorporate art displays or historic information.
- ▶ Designs may also consider solar power to support lighting and heating elements to increase the comfort of waiting passengers.

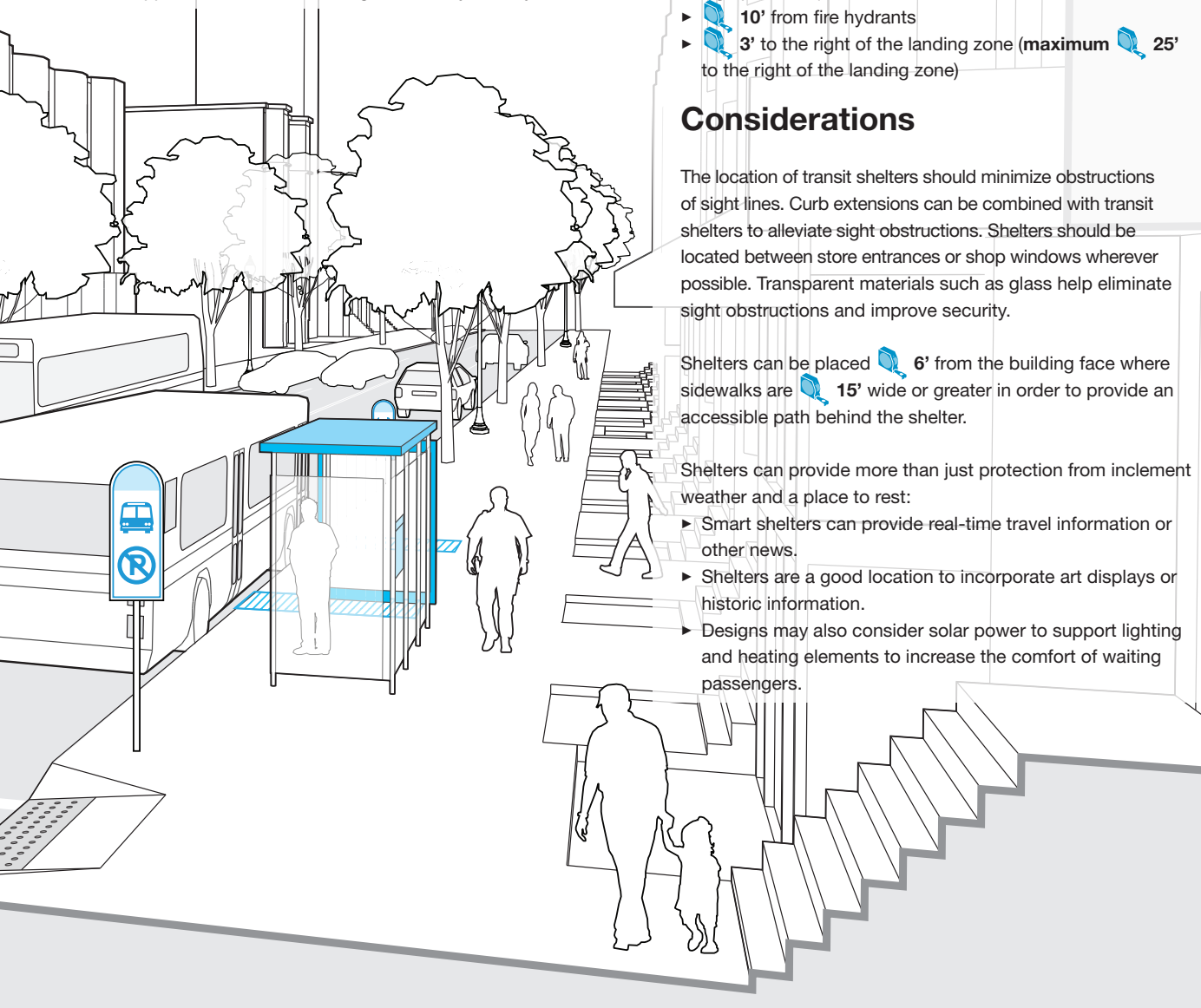



Street Lights

- 90 Street Lights
- 92 Light Fixtures
- 94 Lighting Elements (Lamps)
- 95 Siting and Clearances

Appropriate street lighting facilitates safe movement of traffic and provides a sense of safety and security for pedestrians, but when used effectively, lighting can do much more. Good streetscape lighting lends character to a street, and by highlighting salient features, provide a sense of place and civic pride. Private property owners are critical participants in creating the overall streetscape lighting environment. Municipal street lighting should complement the context and land use of the Street Type, as well as account for existing lighting levels, nighttime design compositions, and aesthetics.

The goal of street lighting is to provide safe, even lighting while reducing energy consumption and costs, light trespass (unwanted light), and dark sky pollution. In the fall of 2010, the Street Lighting Division and the Boston Environment Department initiated a program to replace mercury vapor lamps in existing cobrahead fixtures with LEDs. LEDs require less energy and maintenance and are designed to minimize light trespass and light pollution. LEDs can also enhance visibility, with better color rendering (i.e., colors appear more natural) and a more even spread of light, eliminating the need for over lighting. The switch to LED lighting has the significantly reduced the City's energy use and greenhouse gas emissions.

The Street Lighting Division of PWD manages and maintains approximately 67,000 street lights throughout the city, which includes 2,800 gas lights and 1,500 fire alarm lights. In addition, the Street Lighting Division is in a public/private partnership with *Historic Boston* and *Light Boston* to provide architectural lighting of historical landmarks and church steeples around the city. All street lighting designs must be approved the Street Lighting Division.

Street Lights

Overview

The focus of these guidelines is to ensure compliance with the specifications of the Street Lighting Division. This system exists to provide adequate street lighting on Boston's sidewalks, streets, parks, playgrounds, and public spaces. The system also includes lighting to illuminate certain building facades, entrances, plazas, public art, and other important landmarks at the discretion of the Commissioner of PWD.

Street lights should:

- ▶ Facilitate safe movement of pedestrians, bicyclists, and motor vehicles
- ▶ Create an environment that feels safe and secure for pedestrians
- ▶ Improve the legibility of streets, intersections, ramps, transit stops, critical nodes, and activity zones
- ▶ Reveal squares, public spaces, and special districts to encourage nighttime use
- ▶ Enhance the character of the streetscape by using fixtures that are in keeping with the image of the City and the unique look of specially designated districts
- ▶ Use state-of-the-art technology when appropriate to provide effective, energy efficient lighting that minimizes light trespass and is dark sky compliant

Use

- ▶ Lighting should reflect the character and urban design of the Street Type to create a recognizable hierarchy of roads and spaces.
- ▶ Clear and consistent patterns should be used to reinforce the direction of travel and delineate intersections.
- ▶ Pedestrian scale lighting (lower than 20') should be used alone or in combination with roadway scale lighting in high-activity areas to encourage nighttime use and as a traffic calming device.
- ▶ Critical locations such as ramps, crosswalks, transit stops and seating areas that are used at night must be visible and lit.
- ▶ New street lighting must be dark-sky compliant with cut-off fixtures to ensure that a minimum of 95% of emitted light is directed toward the ground.
- ▶ Light poles may be furnished with electrical outlets
- ▶ Clamp on brackets for banners or hanging planters are possible but are not installed or managed by the Street Lighting Division. They are considered enhanced treatments that require maintenance agreements.



Considerations

- ▶ Paired alignment of light poles across a street provides a formal look that reinforces the direction of travel.
- ▶ Staggered arrangement of light poles provides a less formal look that may allow for fewer lights.
- ▶ On Neighborhood Residential Streets, a staggered arrangement is preferred over lighting on one side of the street to provide more uniform lighting.
- ▶ As LED technology develops, future consideration should be given to providing network control to allow for color control as a way to highlight locations during emergencies.



Light Fixtures

The Street Lighting Division currently maintains 19 different types of light fixtures but is working to streamline the selection to help create a consistent image for the City and to simplify maintenance. The basic set of standard fixtures includes the Pendant, Acorn, and contemporary LEDs.

Pendant: The Pendant fixture is based on the 1907 fixture designed for Memorial Drive, which fixture was the first electric over-the-road fixture used on Boston. Prior to this, fixtures over the road were on cables.

Acorn: The Acorn fixture is the current incarnation of the Boston Post Light, which has been used with slight variations over time since the early 1900s. LED versions are now required for energy savings and to reduce dark sky impacts.

Contemporary LED: The City is in the process of reviewing designs for contemporary, LED based fixtures that can be used in certain locations and special redevelopment areas such as the Boston Innovation District. LED technology is in a rapid phase of development—new fixtures are being developed each year.

Special District Lighting

In addition to the standard fixtures, there are a number of unique styles that are used to distinguish the character of certain Historic Districts and some specially designated redevelopment areas.

Examples of special district lighting include:

- ▶ Beacon Hill
- ▶ Back Bay
 - ▶ Marlborough Street
 - ▶ Newbury Street
 - ▶ Commonwealth Avenue
- ▶ Fort Point Channel
- ▶ Dewey Square
- ▶ Convention Center/Seaport District

All street lighting installations in Historic Districts must be reviewed and approved by the appropriate Historic District Commission.

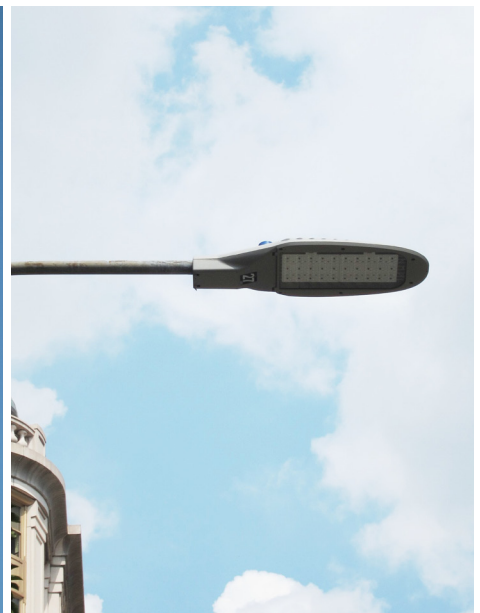

Typical Lighting Fixture Dimensions and Spacing

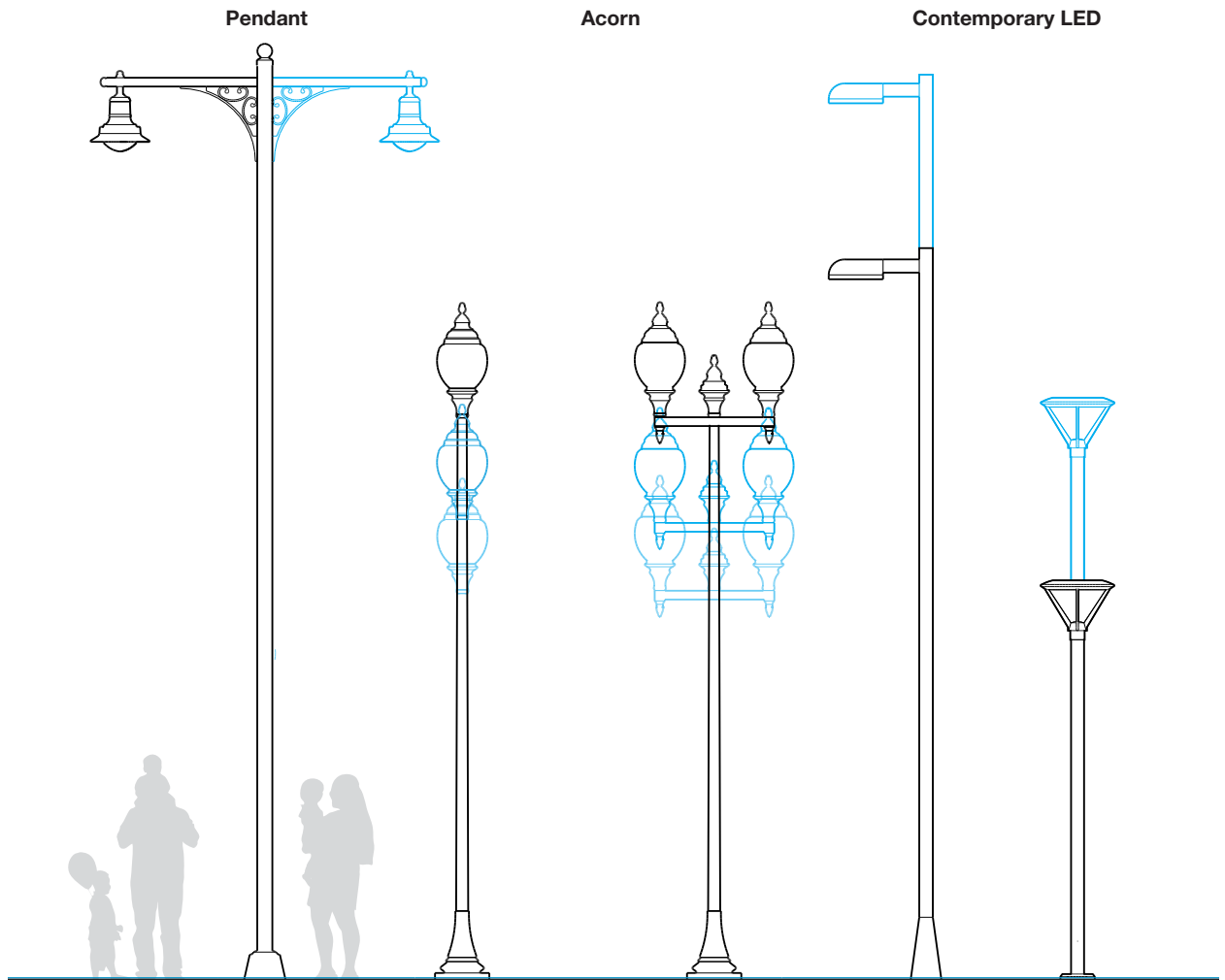

Light Fixture		Typical Shaft Height	Typical Spacing	Typical Use
Pendant	Single	25'	90' to 120'	Boulevards, Parkways, and Neighborhood Connectors
	Double	25'	90' to 120'	
Acorn	Single	11', 13', 16'*	50' to 60'	Boulevards, Downtown Commercial, Downtown Mixed-Use, Neighborhood Main, and Shared Streets
	Double	11', 13', 16'*	75' to 80'	
Contemporary LED	Road Scale (TBD)	20' to 25'	75' to 120'	Boulevards, Neighborhood Connectors, Neighborhood Residential, and Industrial
	Pedestrian Scale (TBD)	11' to 16'	50' to 80'	Downtown Commercial, Downtown Mixed-Use, Neighborhood Main, and Shared Streets

Note: Acorn shaft heights vary: 11' on Residential Street Types in historic districts, 13' in retail districts, and 16' on Boulevards.

Lighting Elements (Lamps)

City standard light fixtures are available with a number of different lamp options that vary with respect to light color, color rendition, efficacy (light output per unit energy), application efficiency (visibility from light falling where needed), and lamp life.

In general:

- ▶ Cooler tones are used in the highest light situations (such as electronic sign districts), while warmer or pure white tones are used in medium to lower light level situations.
- ▶ Light that provides more accurate color rendition is preferred in areas with heavy nighttime activity, as it improves perception and sense of safety.

As part of the City's efforts to reduce greenhouse gas emissions, the City has been installing LED replacements for mercury vapor lamps in cobrahead fixtures throughout Boston. The LED is expected to be the lighting element of choice for future installations for a number of reasons:

- ▶ LEDs offer up to 50% reduction in energy use and GHG emissions by providing light that is more natural and evenly distributed than other sources, allowing for greater visibility with less light
- ▶ LEDs last 12 to 15 years, versus four to five years for other lamp types
- ▶ LEDs can be color controlled to provide good color rendition where needed, such as areas with high pedestrian activity
- ▶ LEDs are directional and can be targeted to prevent light trespass

Illumination Levels

The City of Boston uses the recommended values in American National Standard Practice for Roadway Lighting (Illumination Engineering Society RP-8-00) for LED street lights and follows Federal Highway Administration standards for lighting using High Intensity Discharge (HID) lamps to determine appropriate lighting levels for roadways, walkways, bicycle facilities, crosswalks, and pedestrian underpasses. These levels vary depending first on light type, then street functional classification (major, collector, and local roadways), and level of pedestrian activity or "pedestrian conflict" (high, medium and low).

Please refer to the current version of RP-8-00 for further recommendations on illumination levels.

Guidelines for Lighting Elements

Lamp Type	Color/Tone	Color Rendition	Efficacy (Lumens per Watt)	Application Efficiency	Lamp Life (Years)	Typical Use
LED	White	Good	80	High	10 to 25	All locations with LED compatible fixtures.
High Pressure Sodium	Warm Yellow	Fair	108	Medium	4 to 5	General lighting in areas with medium to low nighttime activity.
Metal Halide	Cool White	Good	78	Medium	4 to 5	Electronic Sign Districts (Theater District, Landsdown Street); other areas with heavy nighttime activity.

Siting and Clearances

Where possible, light poles should be located in the Greenscape/Furnishing Zone and should not impede the Pedestrian Zone. The location of light poles must be coordinated with landscape, civil engineering, utility, and traffic control plans to ensure that appropriate clearances are maintained and that lighting is not obscured by tree canopies.

Note: In existing constrained rights-of-way where the dimensions listed below are not feasible, street lights should be located using engineering judgement.

Minimum Street Light Siting and Clearances

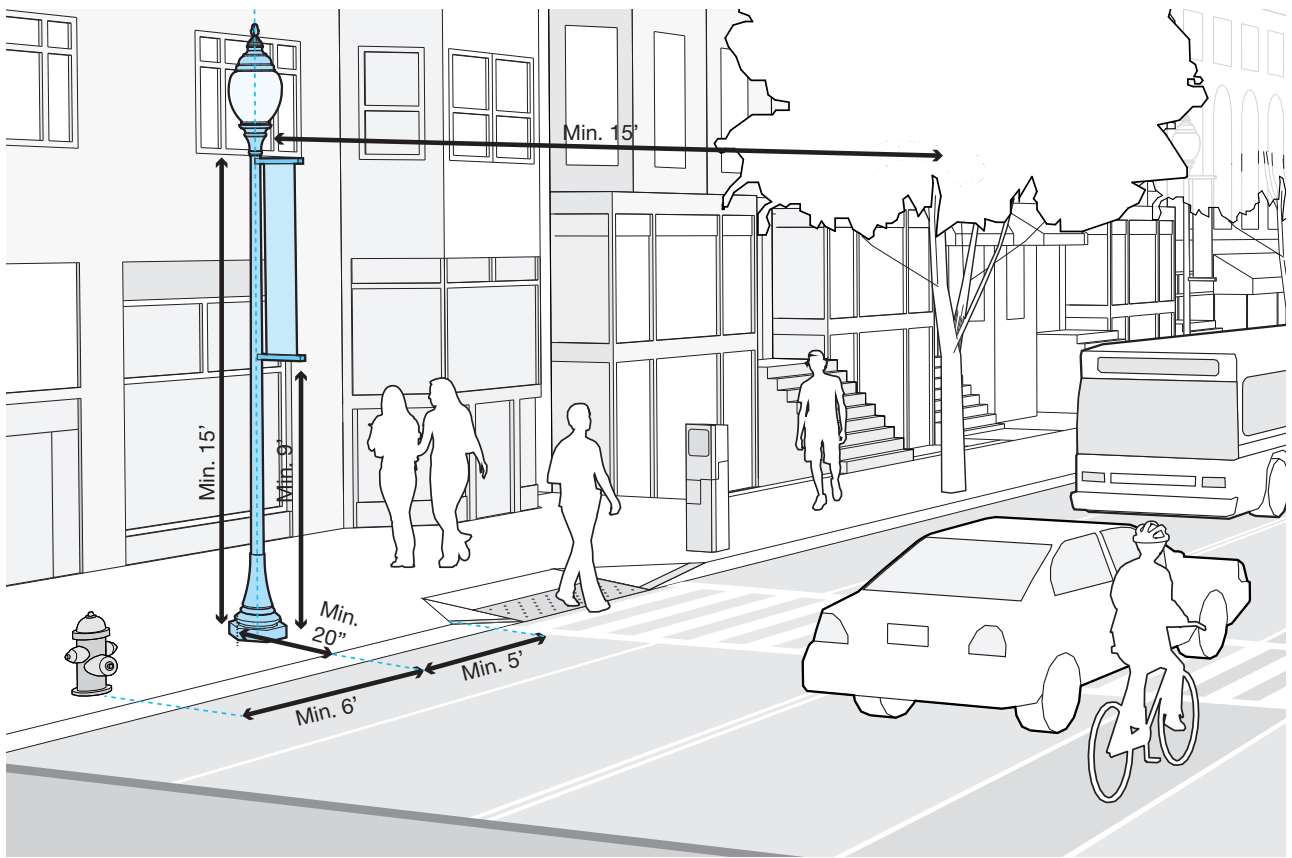

Minimum Street Light Centerline Clearances	Traffic Light or Tree	15'
	Curb Ramp	5'
	Fire Hydrant	6'
Minimum Pole Centerline Setbacks from Curb	Sidewalks <7' Wide	20"
	Sidewalks >7' Wide	2'-3"

Minimum Vertical Clearances for Banners and Hanging Plants*	Banner Brackets	15'
	Bottom of Banner	9'
	Hanging Plant Brackets	13'
	Bottom of Hanging Plants	9'

*Note: Banners and hanging plants must be installed parallel to the roadway.