

# BOQUERIA

## EXTERIOR SIGNAGE SUBMISSION



# DESIGN REVIEW AGENDA

LOCATION OF BUILDING WITHIN DISTRICT

EXISTING NEIGHBORHOOD SIGNAGE REFERENCE

PROPOSED SIGNAGE ELEMENTS

- 25 THOMSON EXISTING CONDITIONS
- 25 THOMSON SIGNAGE DESIGN
- 25 THOMSON SIGNAGE DETAILS

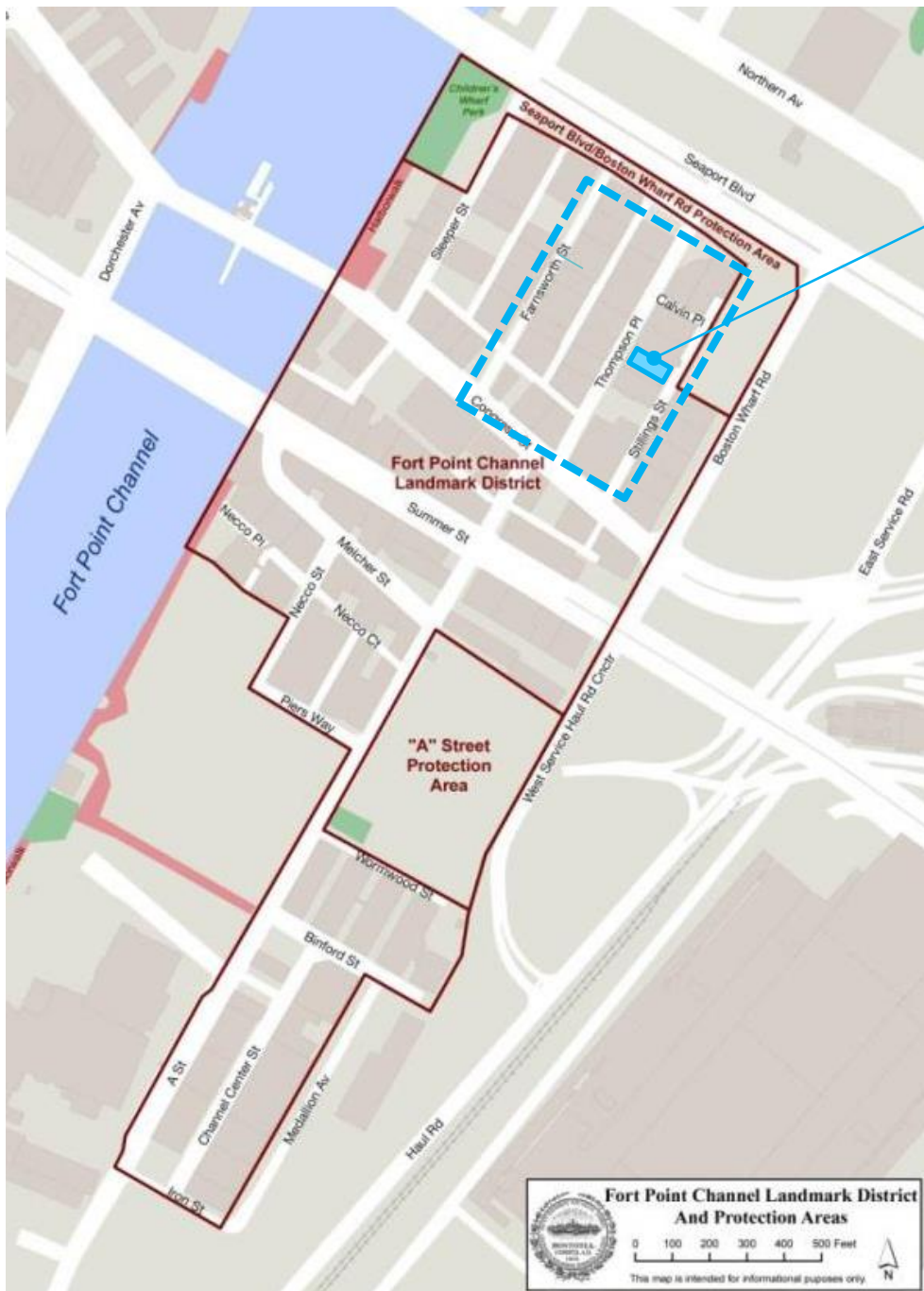

25 THOMSON PLACE



FORT POINT CHANNEL LANDMARK DISTRICT

PROJECT LOCATION MAPS





EXISTING CONDITION PHOTO

25 THOMSON PLACE – VIEW FROM ACROSS STREET





EXISTING CONDITION PHOTO

25 THOMSON PLACE – VIEW FROM STILLINGS STREET





SIGNAGE EXAMPLE FROM OTHER CITIES

FULTON MARKET DISTRICT – CHICAGO, IL





EXISTING NEIGHBORHOOD REFERENCE PHOTOS

ILLUMINATED SIGNAGE





EXISTING NEIGHBORHOOD REFERENCE PHOTOS

MENU DISPLAY CASES



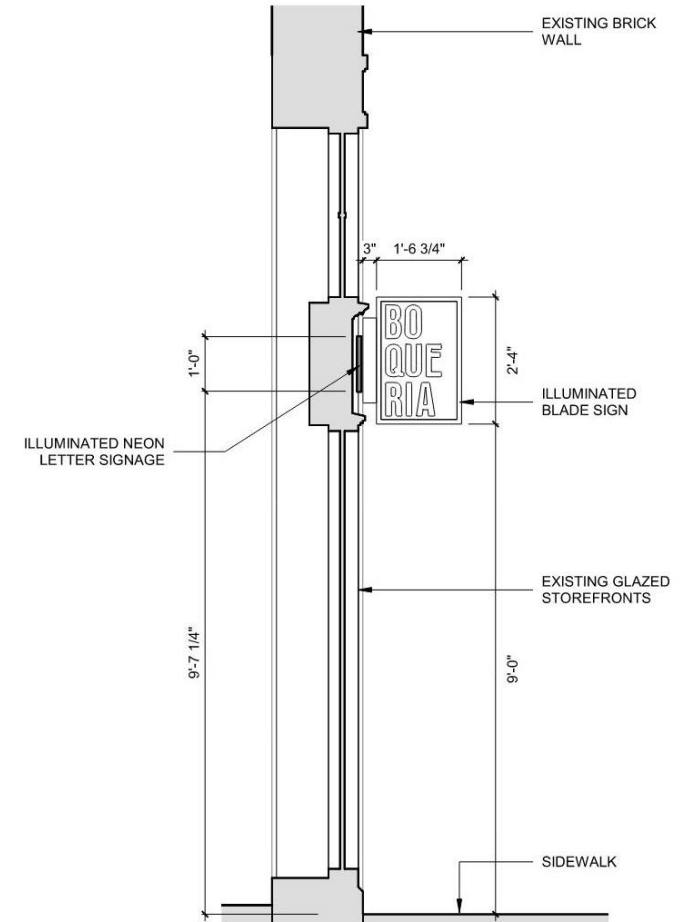
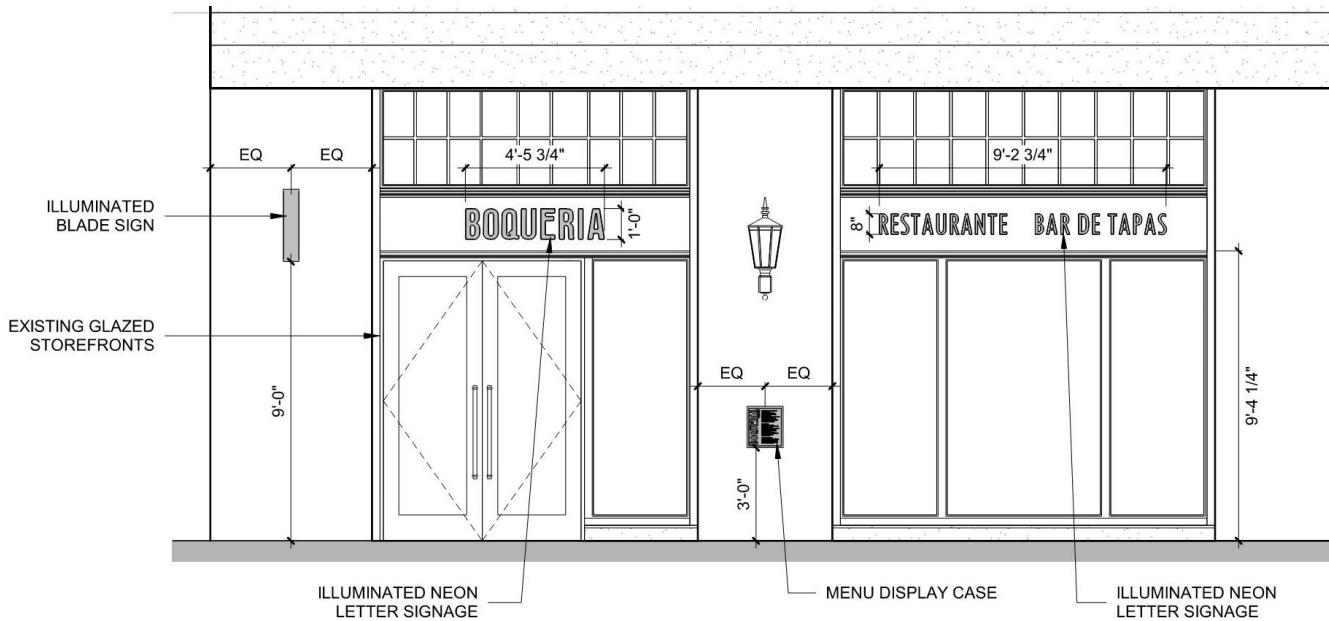

PROPOSED SIGNAGE

THOMSON PLACE - EXTERIOR ELEVATION & TYPICAL WALL SECTION



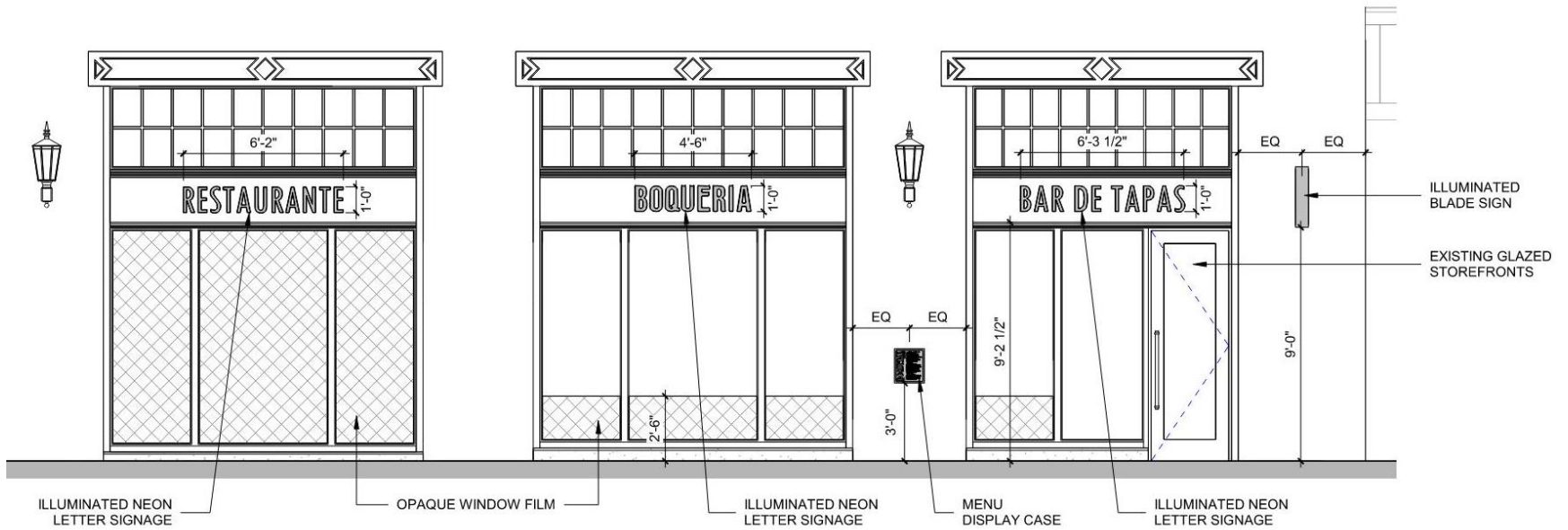

PROPOSED SIGNAGE

STILLINGS STREET – EXTERIOR ELEVATION





PROPOSED SIGNAGE

THOMSON PLACE VIEW – CONCEPTUAL RENDERING





PROPOSED SIGNAGE

STILLINGS STREET VIEW – CONCEPTUAL RENDERING



LETTERING DIMENSIONS ALONG THOMSON PLACE



LETTERING DIMENSIONS ALONG STILLINGS STREET

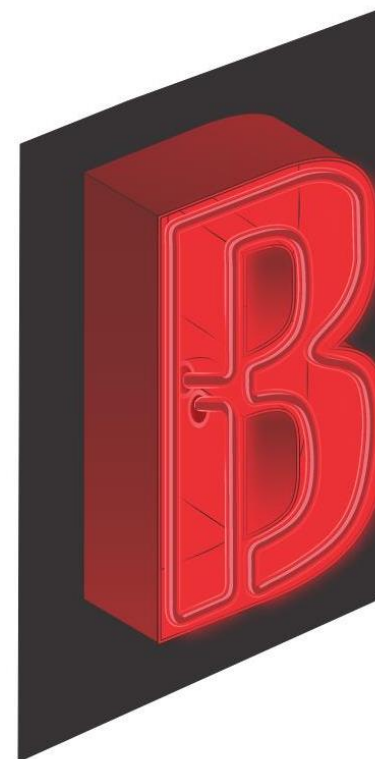
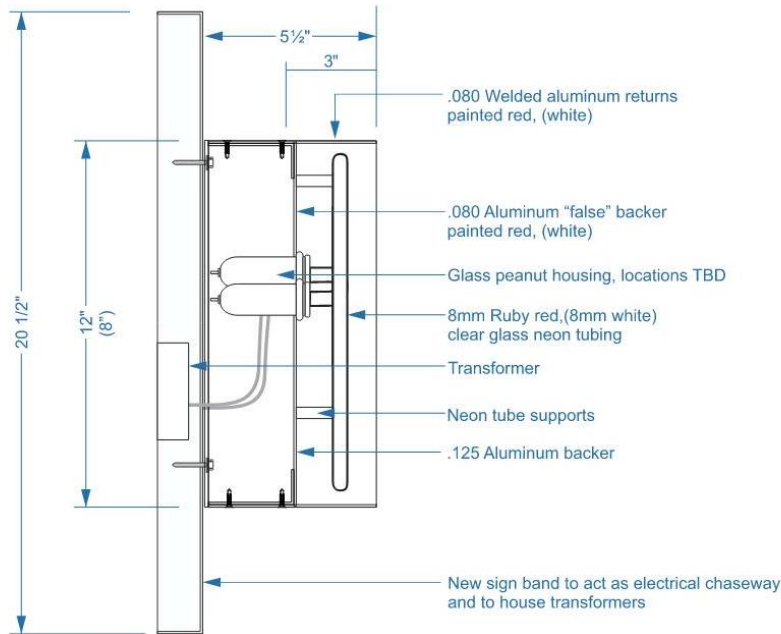

SIGNAGE DETAILS – ILLUMINATED LETTERING



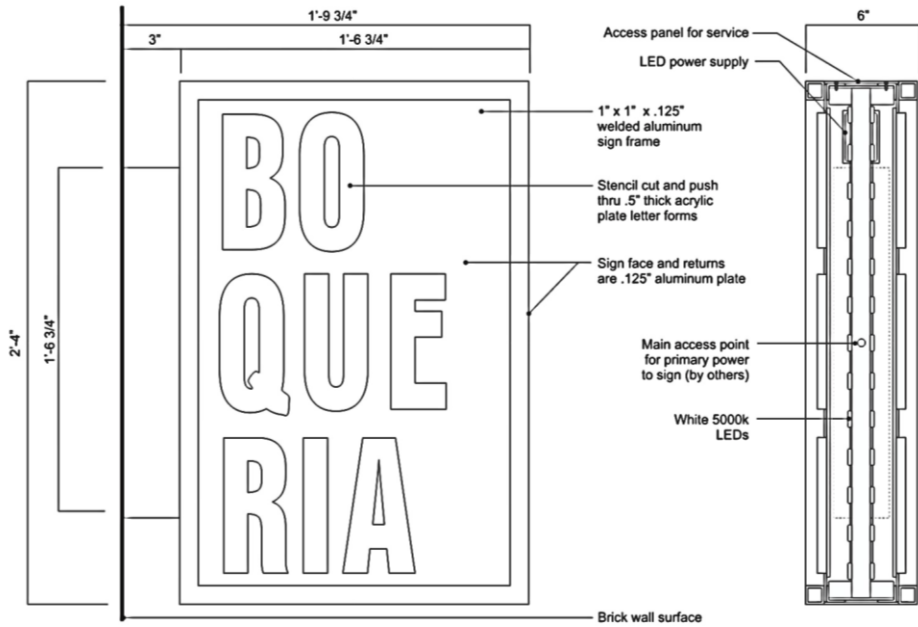

ELEVATION OF  
BLADE SIGN

END VIEW OF  
BLADE SIGN

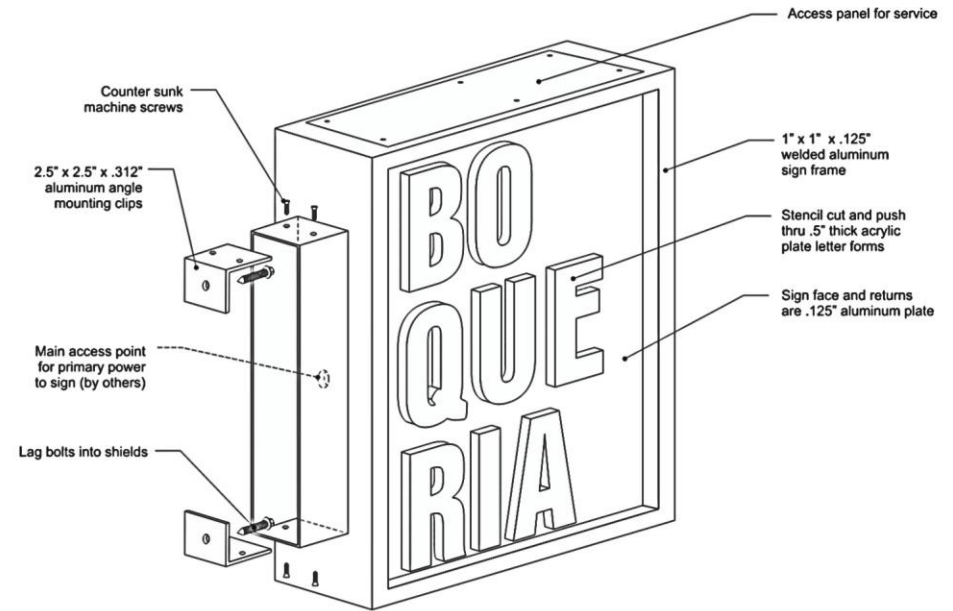

AXON VIEW OF  
BLADE SIGN

SIGNAGE DETAILS – BLADE SIGN

