

# THOMSON PL. FORT POINT

# Thomson Place Placemaking Updates

- 03. Neighborhood**
- 04. Brand Identity**
- 06. Signage & Graphic Updates**
- 17. Lighting**
- 20. Vendors**



# THOMSON PL. FORT POINT

## WHERE INNOVATION MEETS TRADITION

### Key

- Approach 1 (Primary)
- Approach 2 (Primary)
- Approach 3 (Secondary)
- Approach 4 (Secondary)
- Approach 5 (Secondary)
- Approach 6 (Secondary)



# THOMSON PLACE

## FORT POINT

THOMSON PL.

THOMSON PLACE  
FORT POINT



THOMSON PLACE  
FORT POINT

THOMSON PL.  
FORT POINT

THOMSON PLACE  
FORT POINT



# SIGNAGE & GRAPHIC ADDITIONS

# THOMSON PLACE/FARNSWORTH STREET E SOUTH - FACADE UPDATE

Brick Wrap - applied to surface to look like a mural. Applied, removable, and replaceable with heat and without damage to the brick

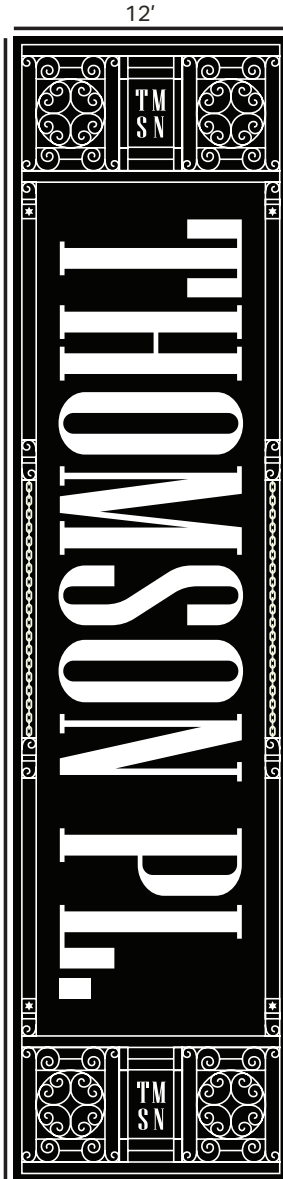
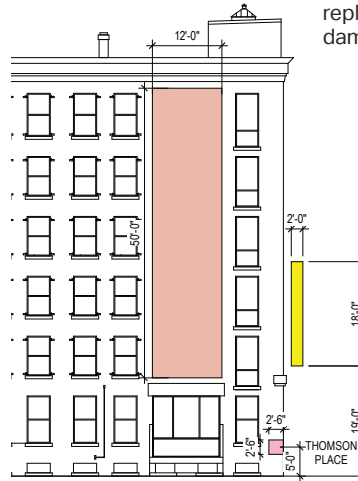

Existing / Inspiration

Artwork

Existing

Proposed

## 25 THOMSON PLACE E SOUTH: BAR TACO WALL

Using the area as our inspiration we will highlight innovation over time with a large graphic incorporating industrial cues from the neighborhoods rich history paired with language to create a sense of place. We will also include the new logo and mark.

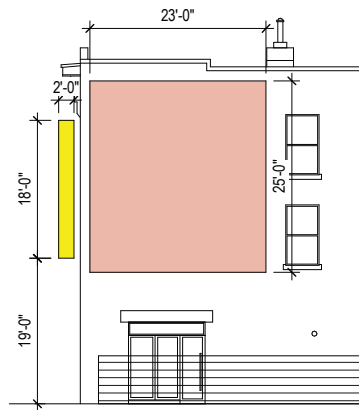

Existing

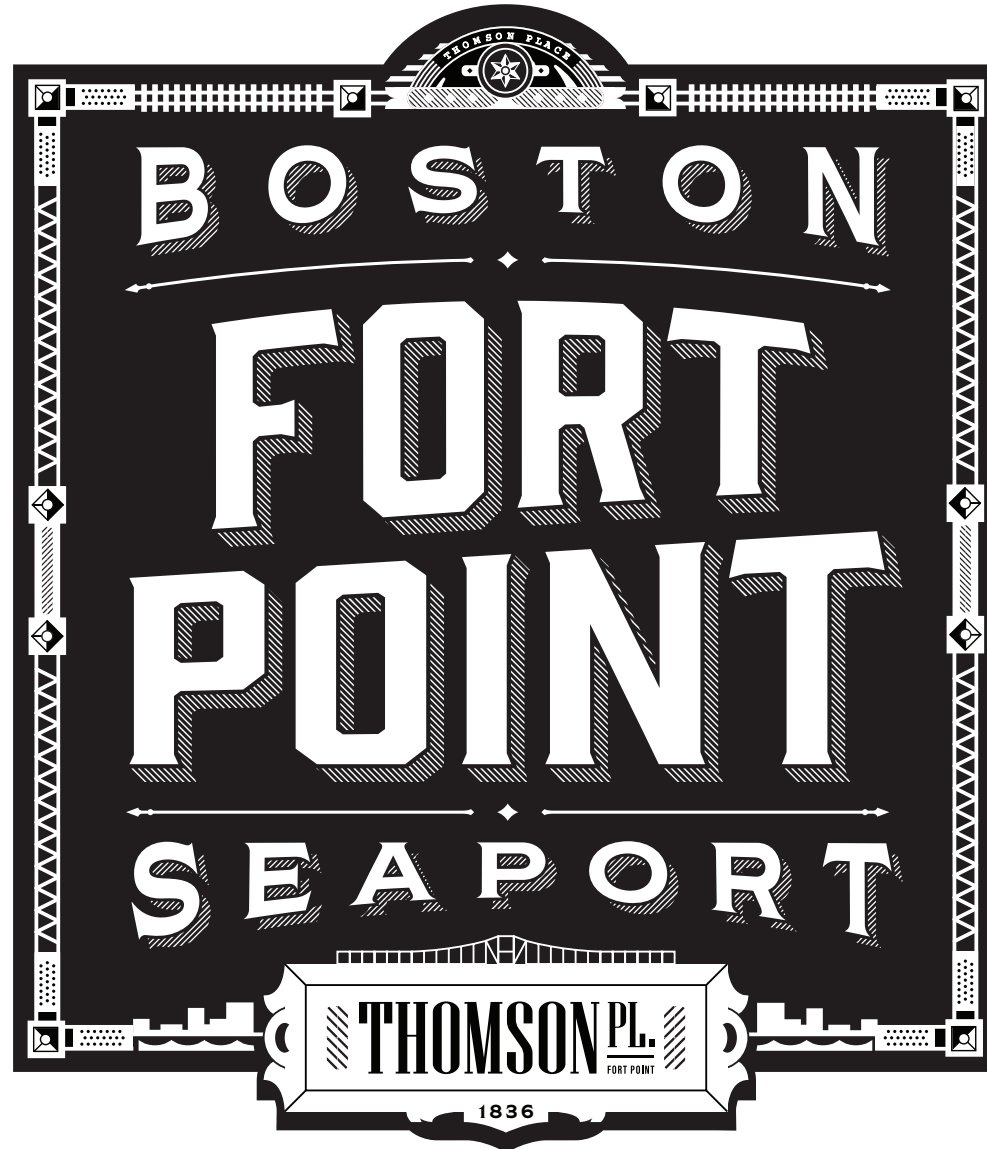

Artwork



Proposed Placement



## 25 THOMSON PLACE E SOUTH: BAR TACO WALL ALTERNATIVE

Using the area as our inspiration we will highlight innovation over time with a large graphic incorporating industrial cues from the neighborhoods rich history paired with language to create a sense of place. We will also include the new logo and mark.



Existing

Artwork



Proposed Placement

# AWNINGS WITH BLADE SIGNS

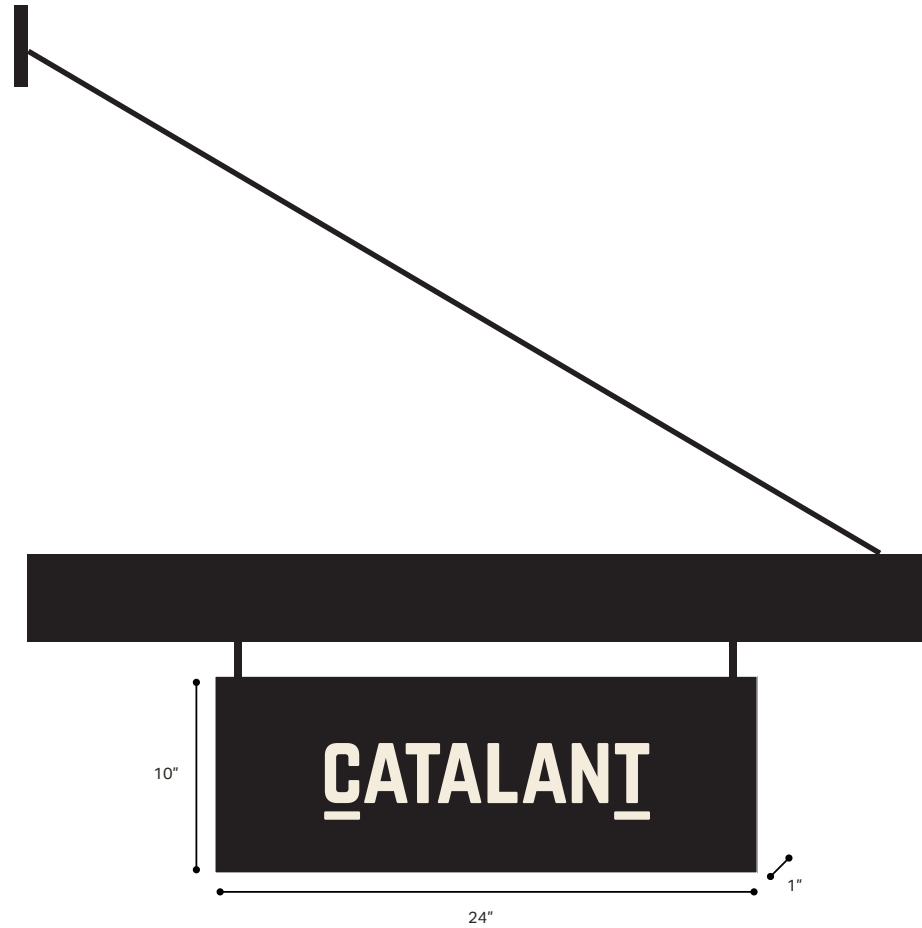
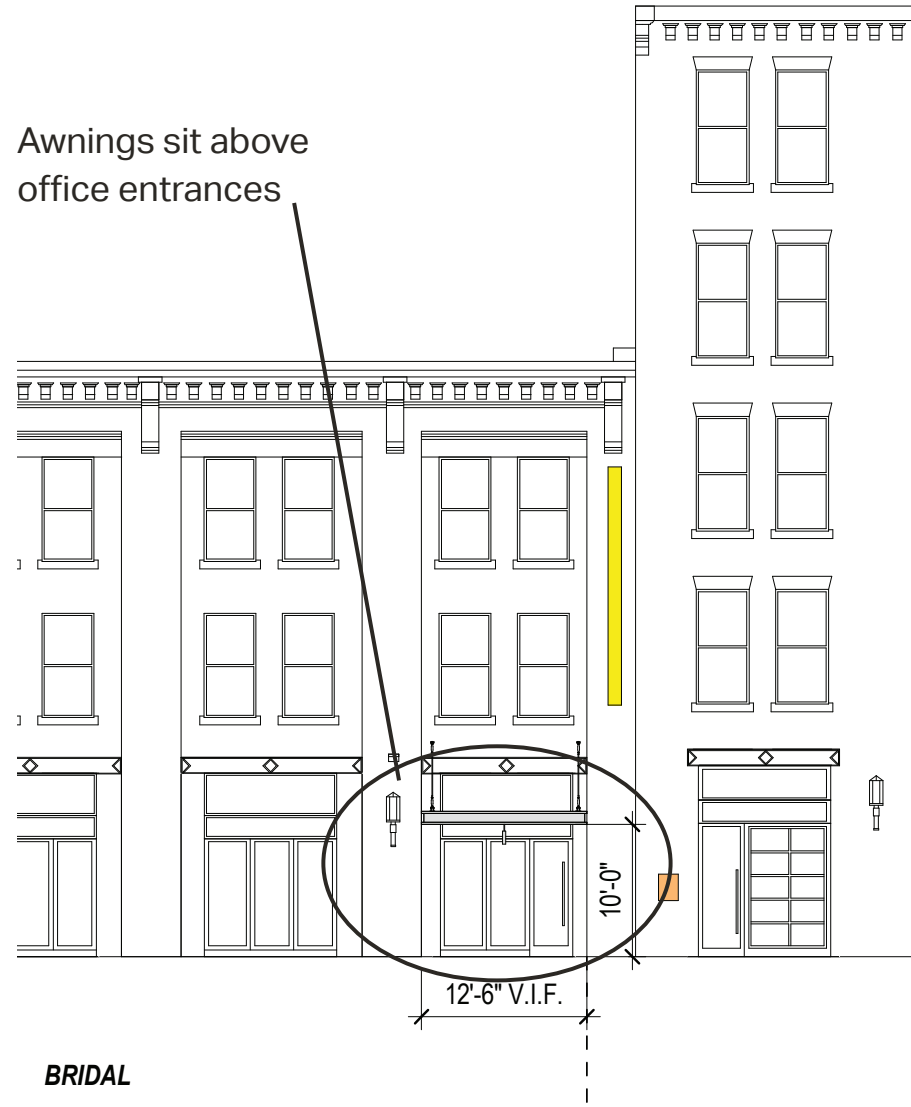

Neighborhood Precedence: 11 Thomson Place

Pin mounted logo. Spot Lighting to highlight blade sign.

\*Option to propose updates to current tenants along with new/incoming tenants

**BRANDED BANNERS**

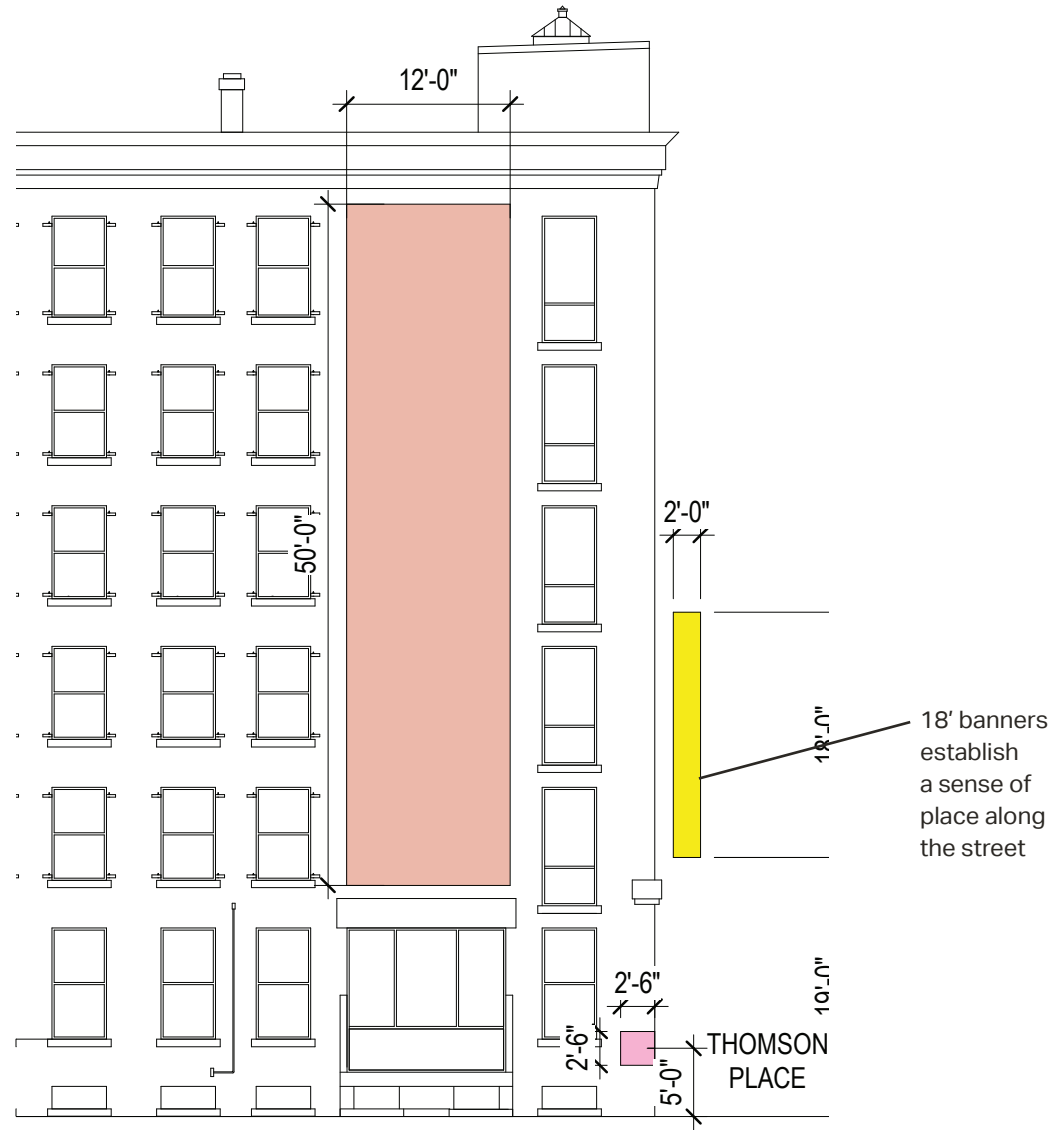

Proposed



THOMSON PLACE  
FORT POINT



Neighborhood precedence  
Congress and Thomson, Seaport Boston MA.

BRANDED BANNERS: CONTENT OPTIONS



Generic Thomson Branding



Highlight Tenants

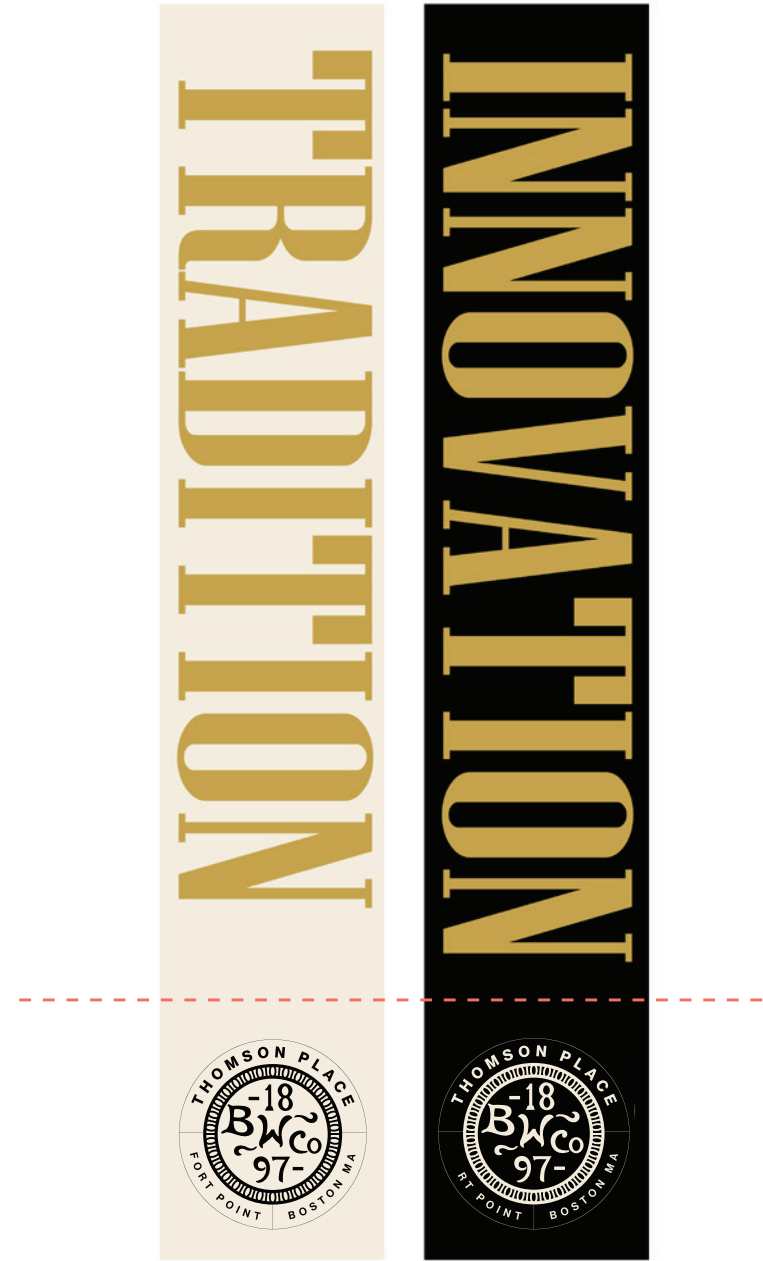

Future State: storytelling, promotional content, Ex. Alternating Innovation and Tradition

# BANNERS



# CORNER WAYFINDING

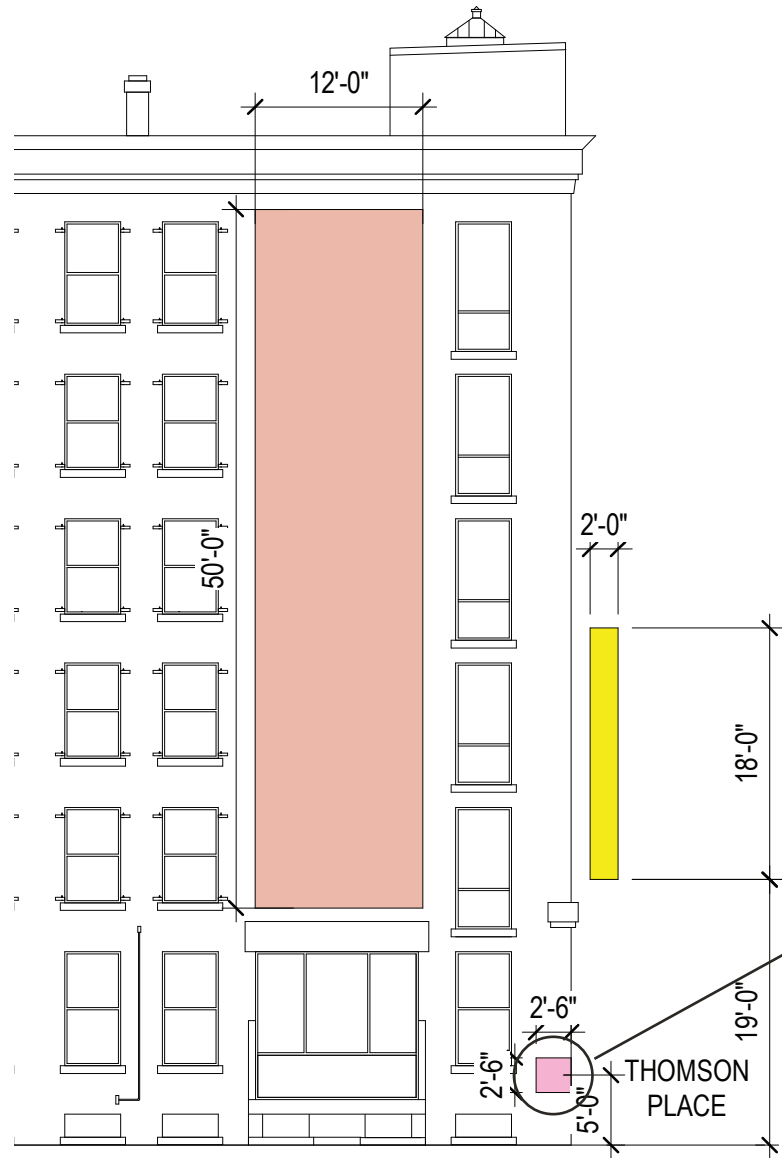

Corner wayfinding - wrapping around the corner of buildings

Pin Mounted

Black Metal, decal names and arrows to easy updates



Proposed



# TENANT PLAQUES

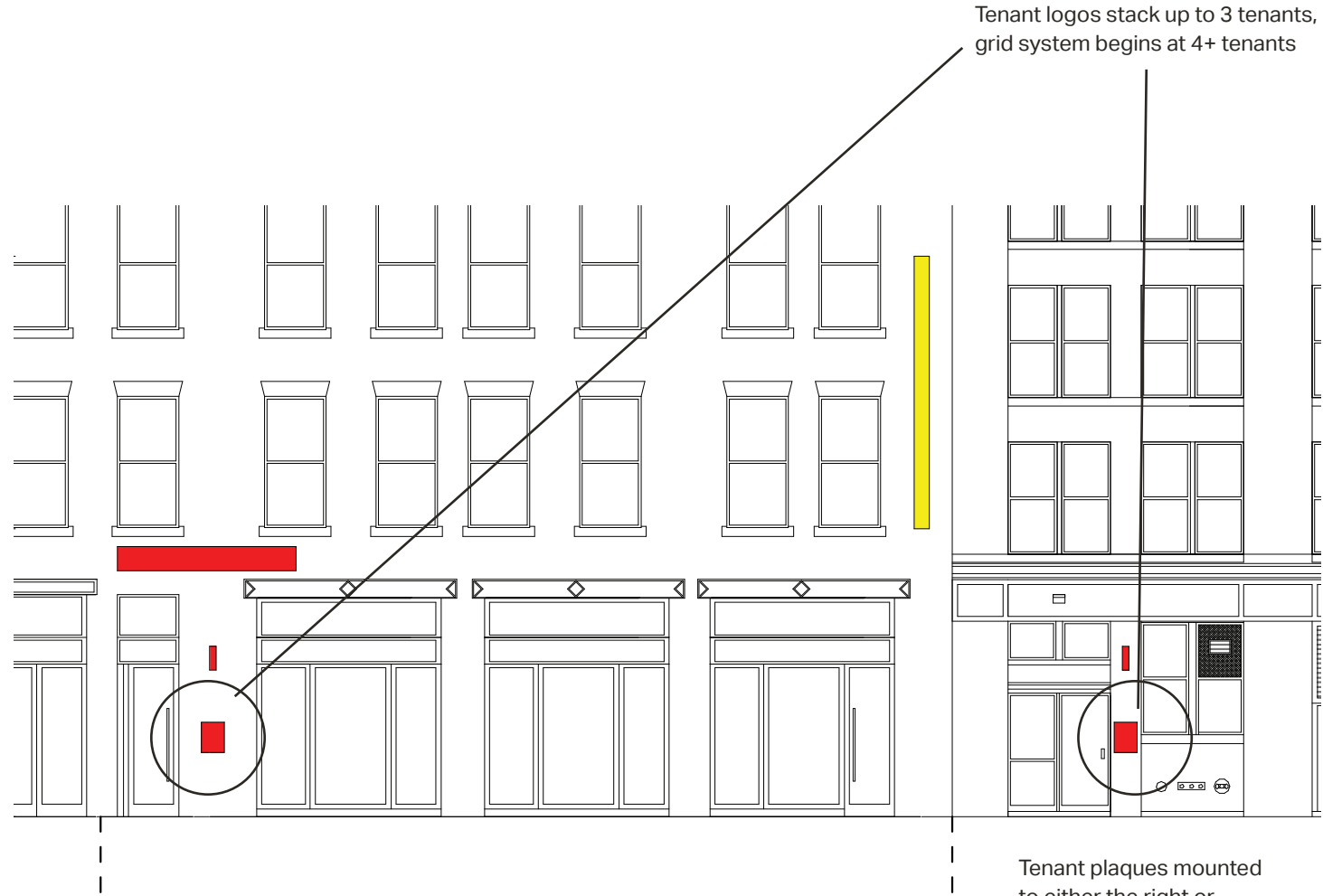

Tenant logos stack up to 3 tenants, grid system begins at 4+ tenants

Tenant plaques mounted to either the right or left entrance of main entrances

Pin Mounted

Black metal

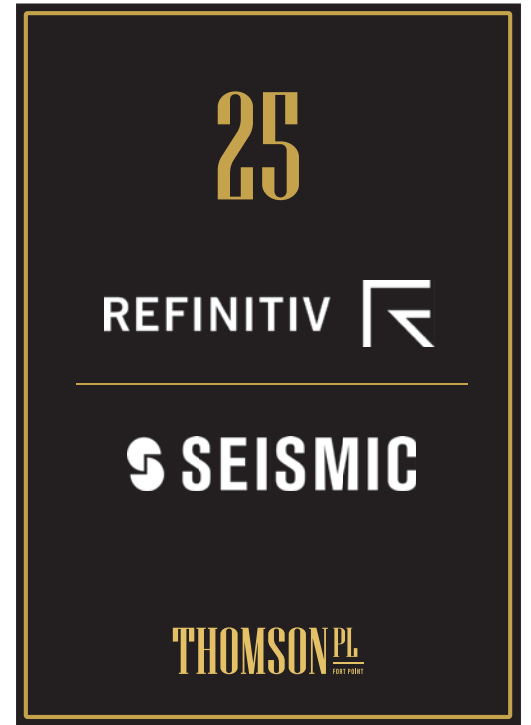

**PARKING SIGNS**

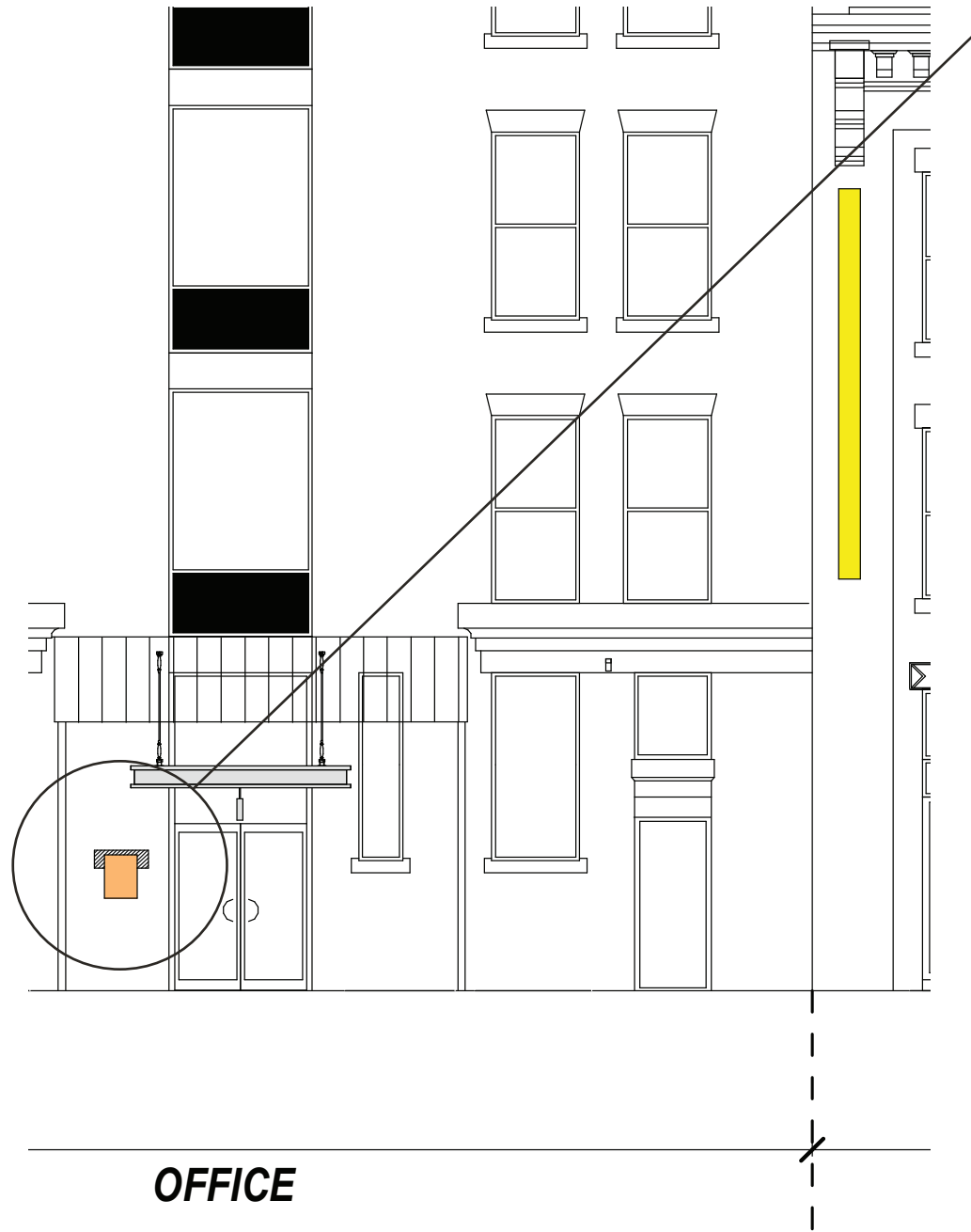

Branded parking signage to replace existing parking signage. Unified under the Thomson Place brand



Existing

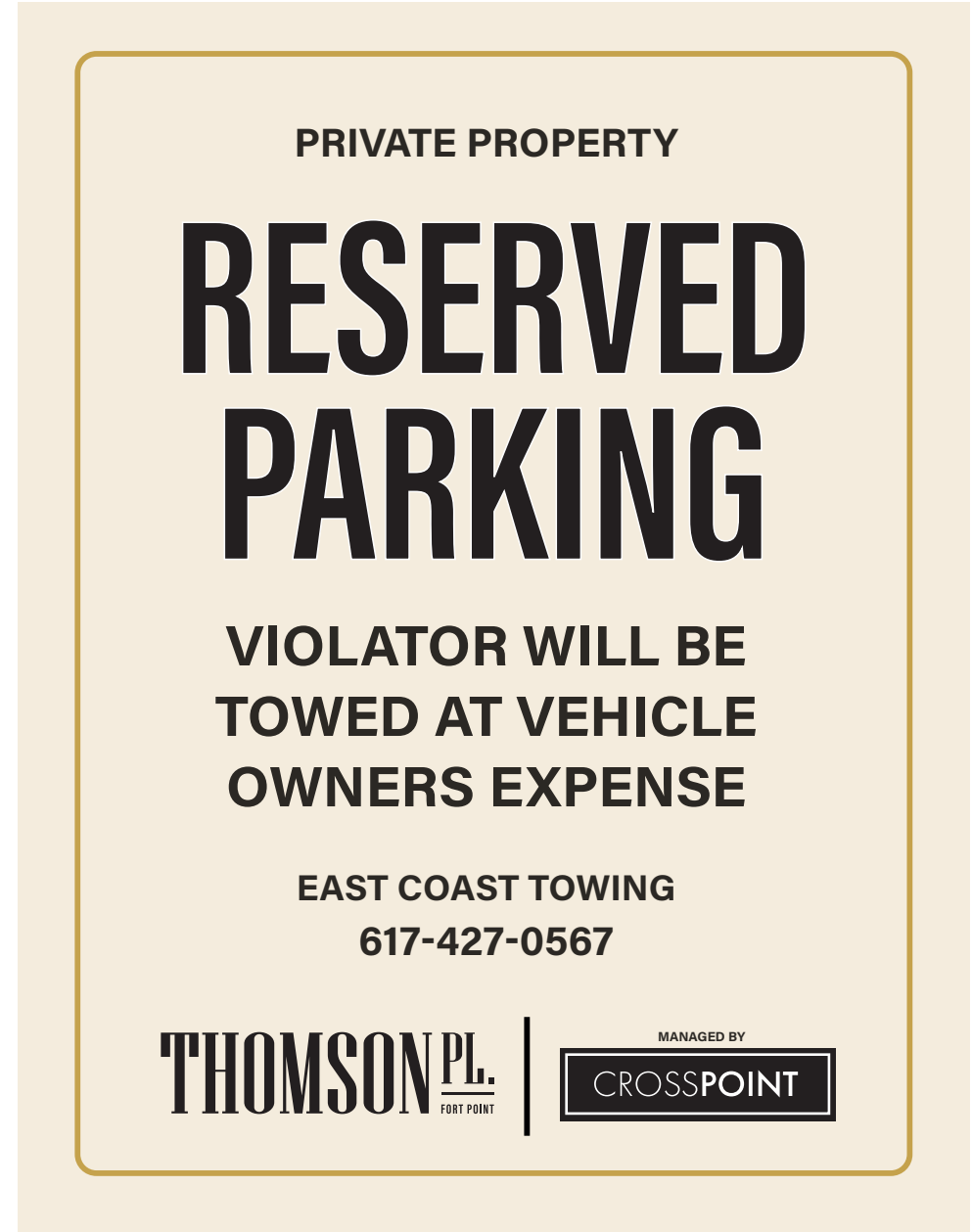

Proposed



# WINDOW CLINGS



**RETAIL FOR LEASE**

General Vacancy

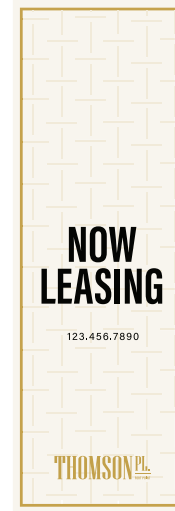
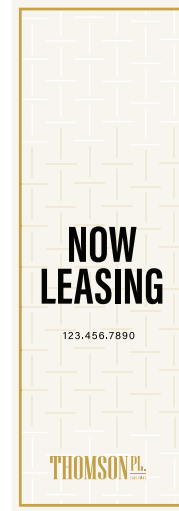

Proposed

Coming Soon, Tenant Design

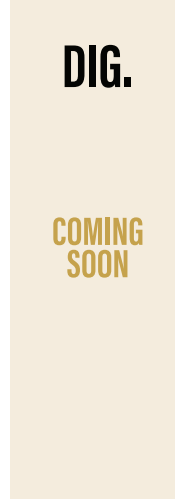

Proposed



Proposed



Proposed

Sizes to be verified on site. Graphics to be supplied by tenants following Thomson Place Fort Point brand guidelines

# LIGHTING

# LARGE LIGHTING ENHANCEMENTS



Existing



Proposed: Double the quantity of current 1/3 VILLAGE 375 LVC Catenary Suspended. This includes increasing the count on the current strands and adding new



# BUILDING LIGHTING



**Sample placement**  
Thomson Place Elevation West



**Existing:** Large lighting pendants on facade

**Proposed:**  
Draw the eye up with spot pendants illuminating up and down to highlight the brickwork and facades.

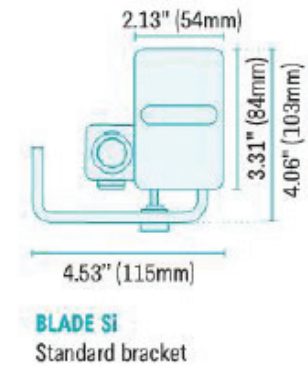
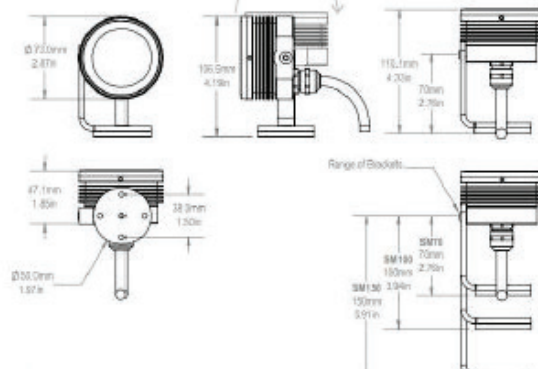
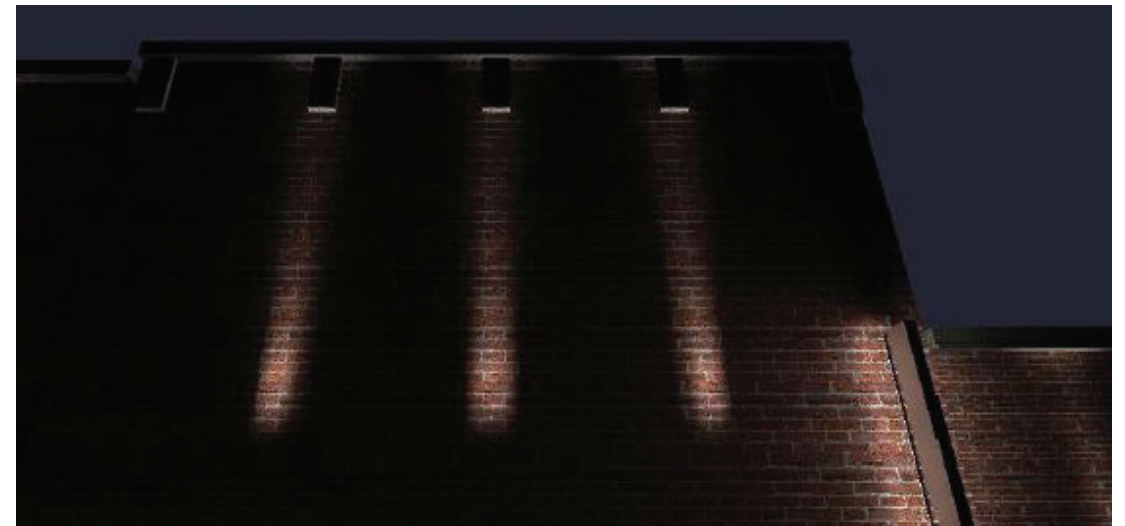
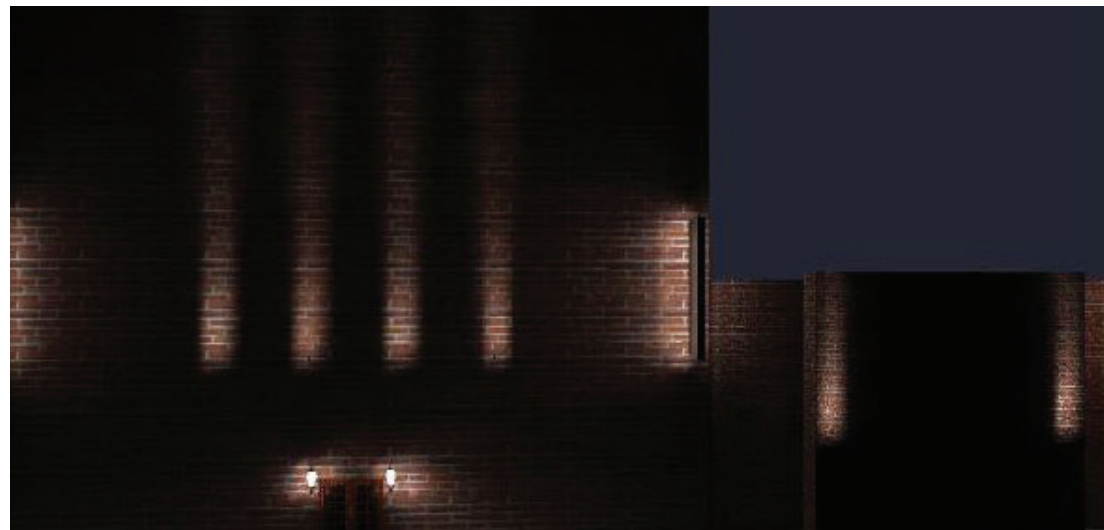

# SPOT LIGHTING

Additional lighting proposed on the Thomson Place branded murals and on new awnings enhancing tenants

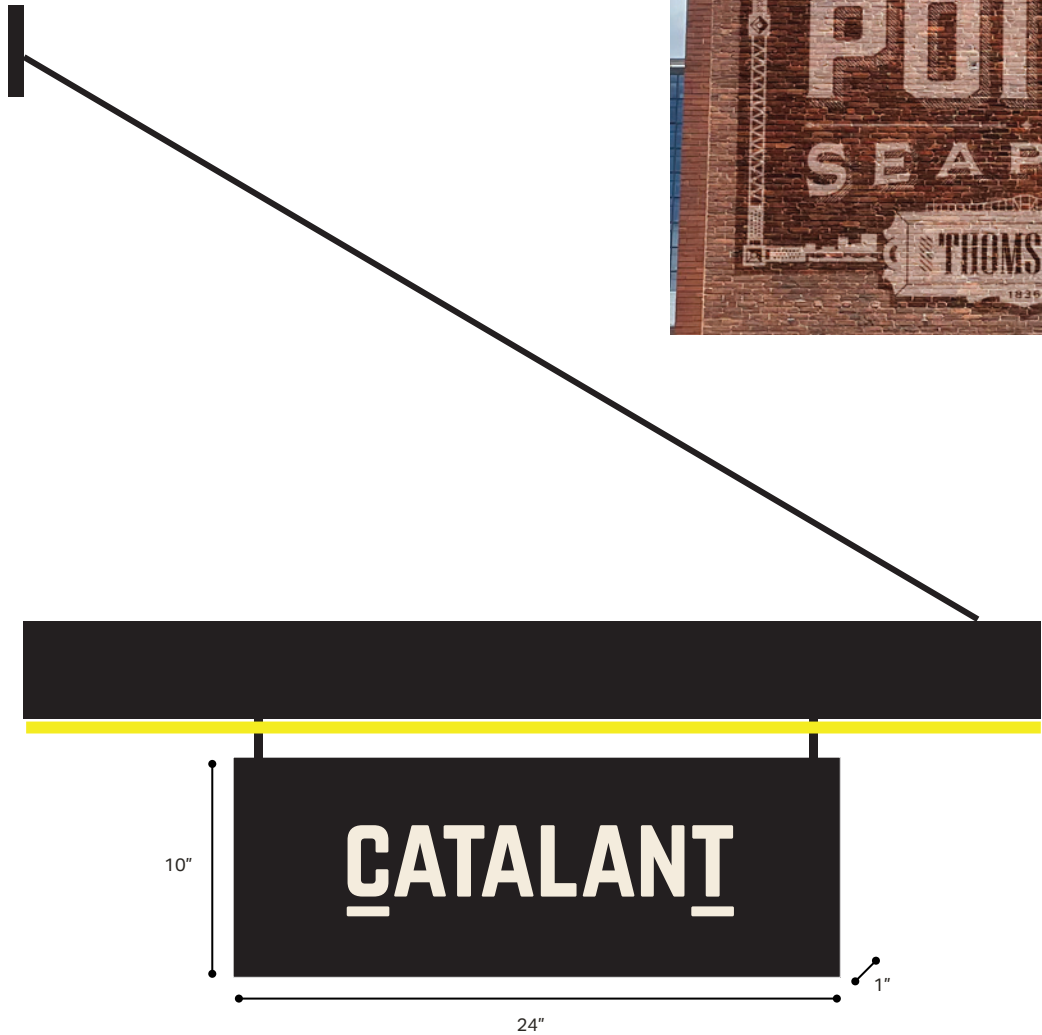

Proposed: Lighting highlighting tenants on awning signage

Proposed: Lighting over brick wrap murals. Spot lighting on "TP" upper brick wrap mural

# VENDORS

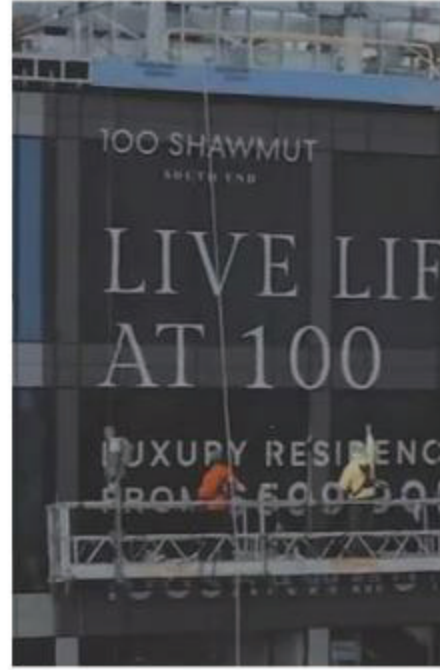

### Singage/Wayfinding/Art

#### Boston Building Wraps

Location: Boston MA

<https://bostonbuildingwraps.com/>

**Details:**

Experience: The Hub, Boston

Exterior Signage/Wayfinding

Building coverings

Custom outriggers

Mural alternatives

### Lighting

#### Illuminate New England

Location: Burlington MA

<https://illuminate.com/eastern/>

# ELEVATIONS



# ELEVATIONS



Thomson Place Elevation East



35 Thomson Place, Elevation North



19 Thomson, Elevation South

# ELEVATIONS



Farnsworth Elevation

Farnsworth Elevation South



Thomson Place, Elevation West

# ELEVATIONS



Stillings Elevations West

**THANK YOU**