

500 R COLUMBUS AVE.

LANDMARKS SUBMISSION

MASSACHUSETTS AVE.

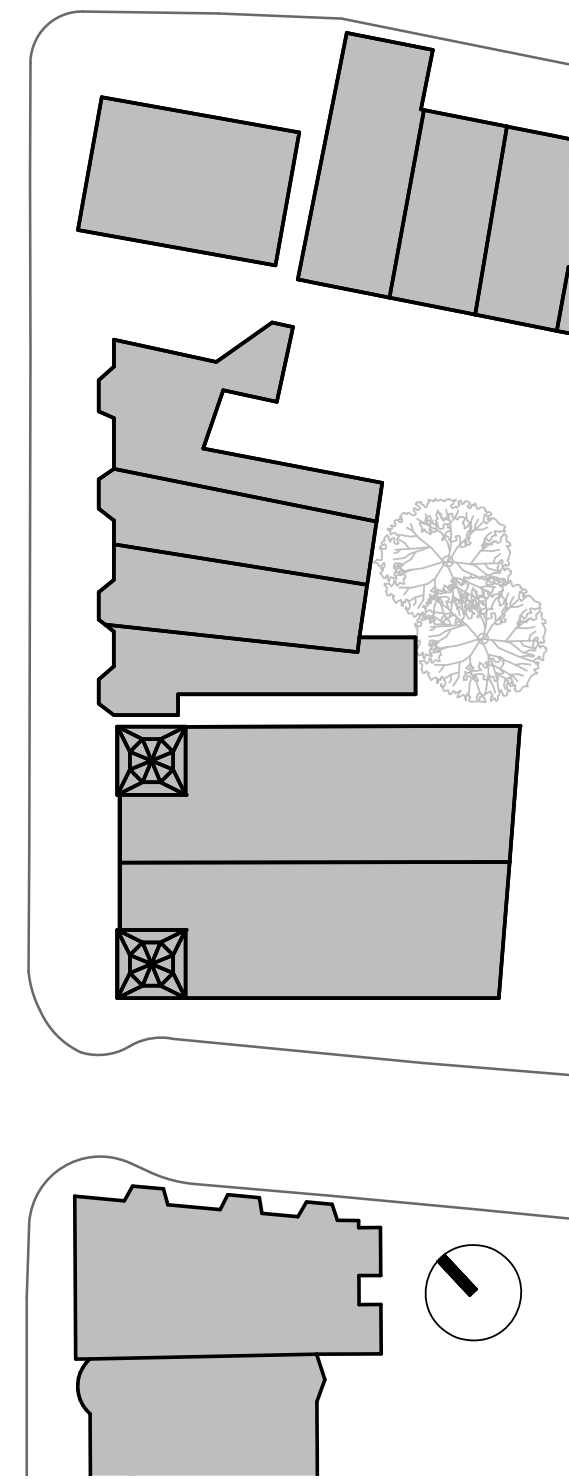

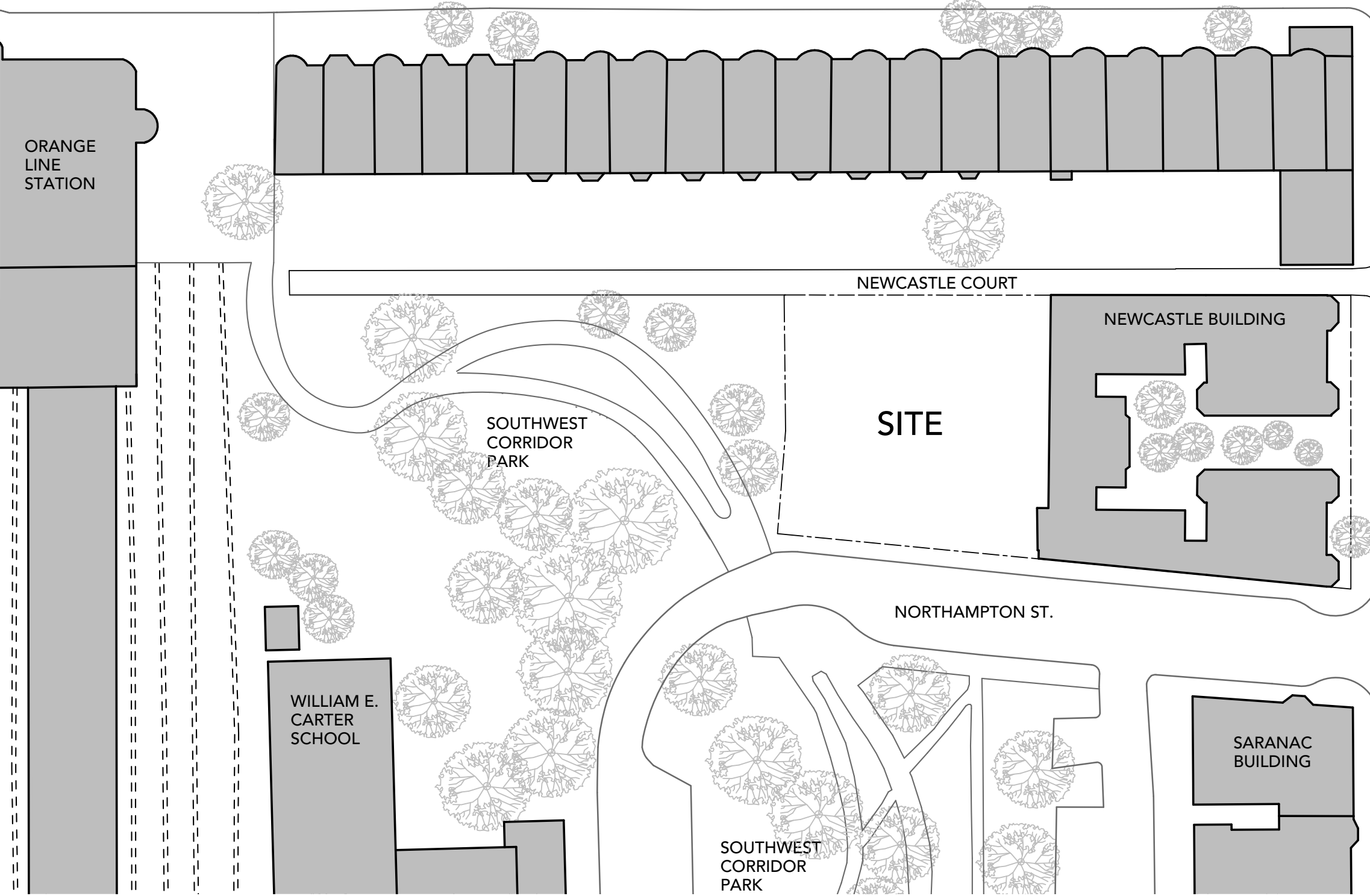

SITE

EXISTING SITE IMAGES



NEWCASTLE BUILDING



COMMISSION COMMENTS:

- ADD DEPTH TO FACADE BY SETTING WINDOWS BACK FROM FACE OF BRICK

- REFINE DETAILS AND ADD TEXTURE AT BUILDING BASE TO INCREASE VISUAL INTEREST

- MAKE ENTRANCE MORE PROMINENT AND WELCOMING

- CONSIDER PLANTINGS AT BASE





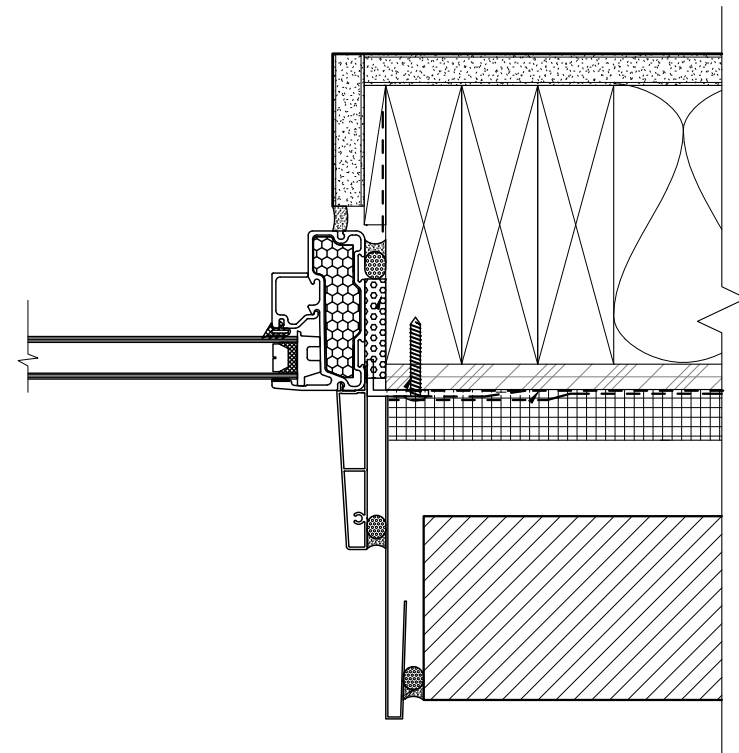
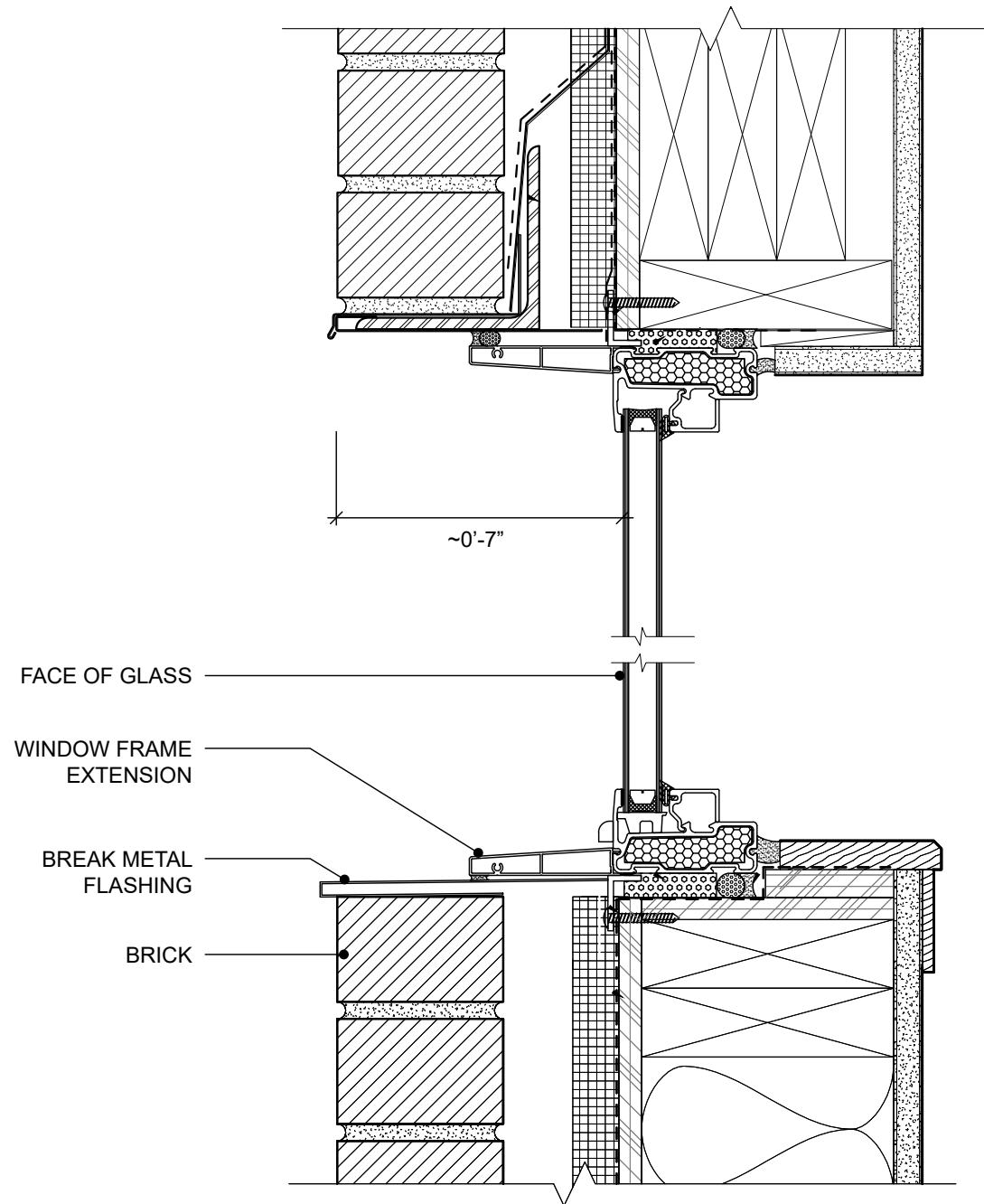







BRICK TEXTURING AT BASE

STONE WATER TABLE

MATERIAL CHANGE AT ENTRANCE RECESS



STONE LINTELS ABOVE OPENINGS

WOOD ENTRANCE DOOR NO LONGER RECESSED

GLASS SIDE LITES

PLANTINGS



APPENDIX



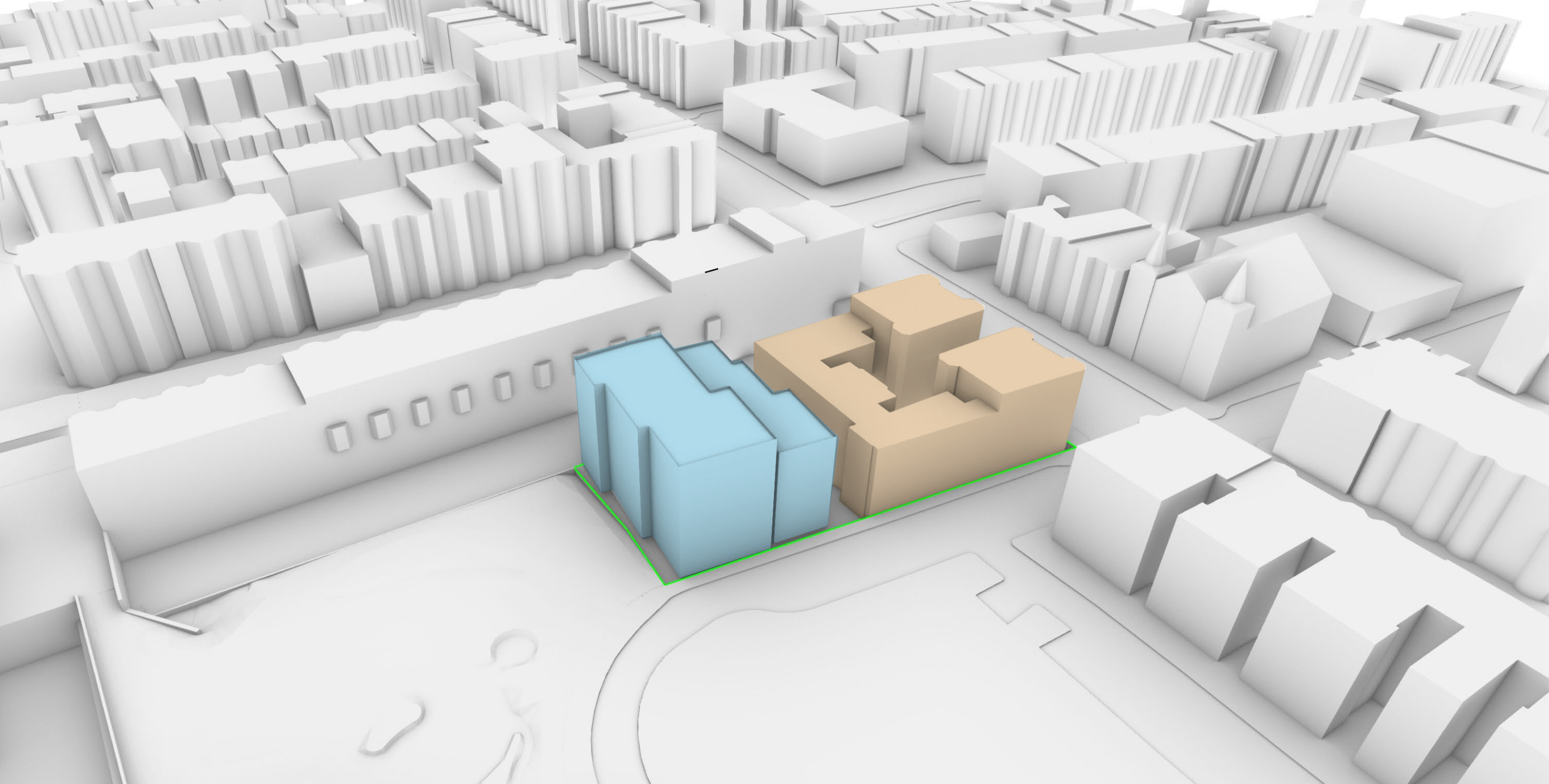

PROPOSAL AND CONTEXT

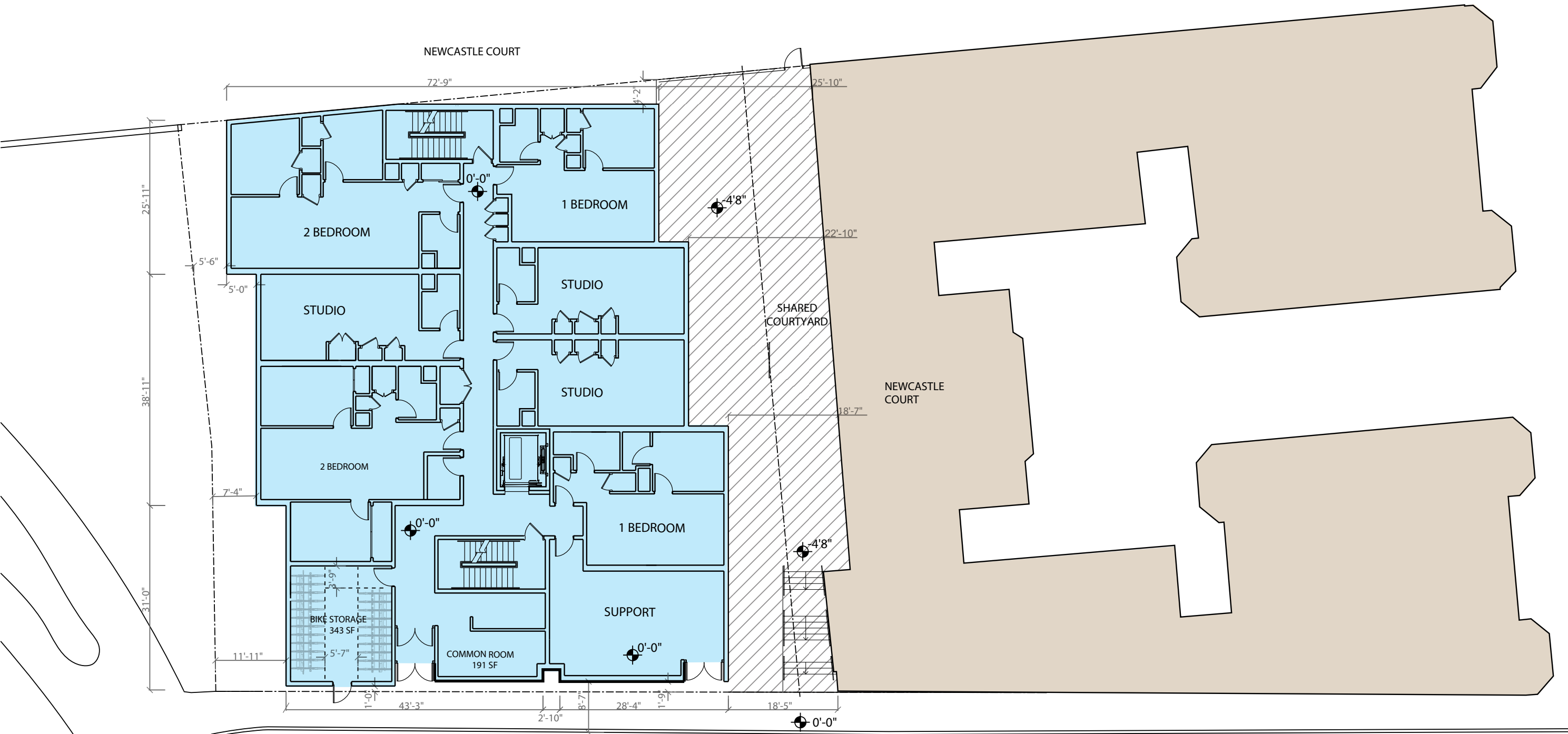

GROUND LEVEL PLAN

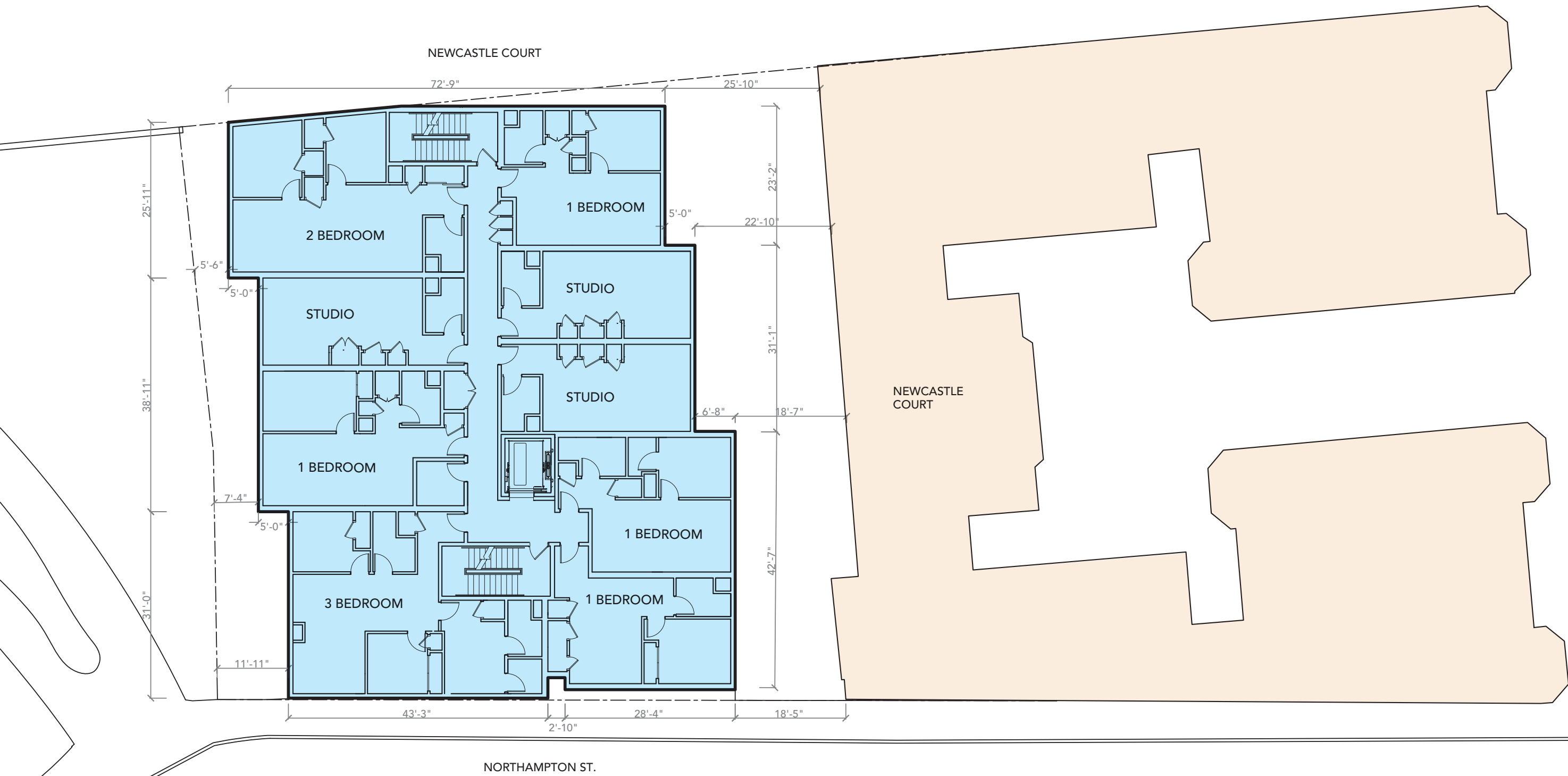

TYPICAL PLAN

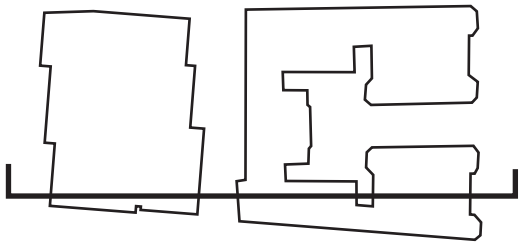
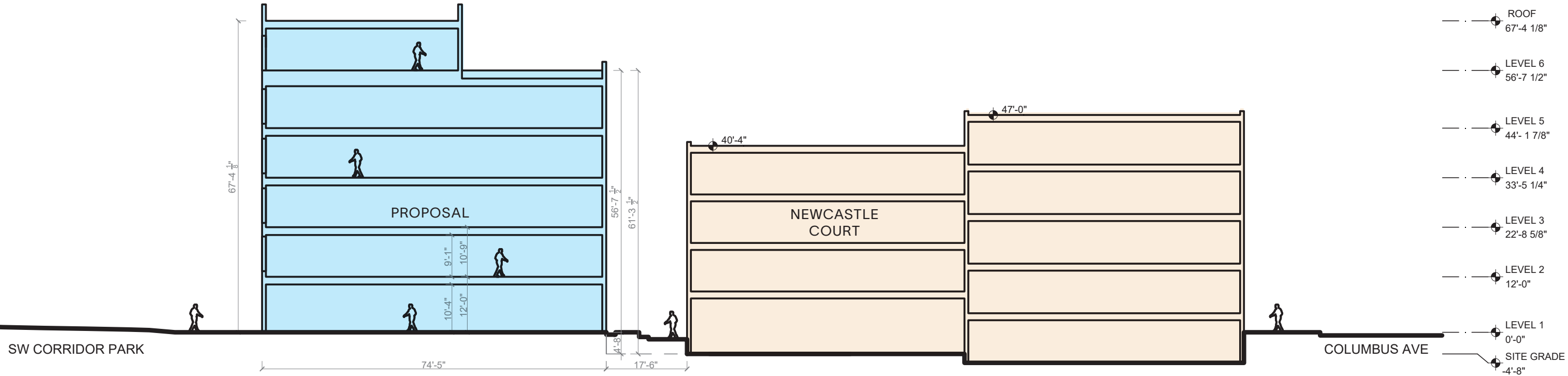

EAST / WEST SECTION

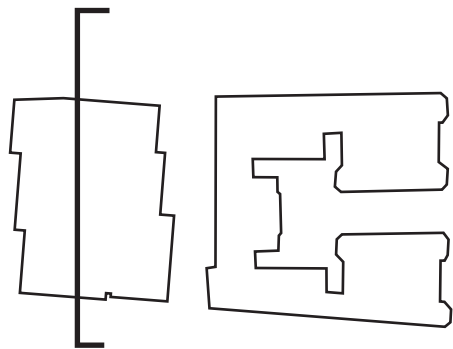
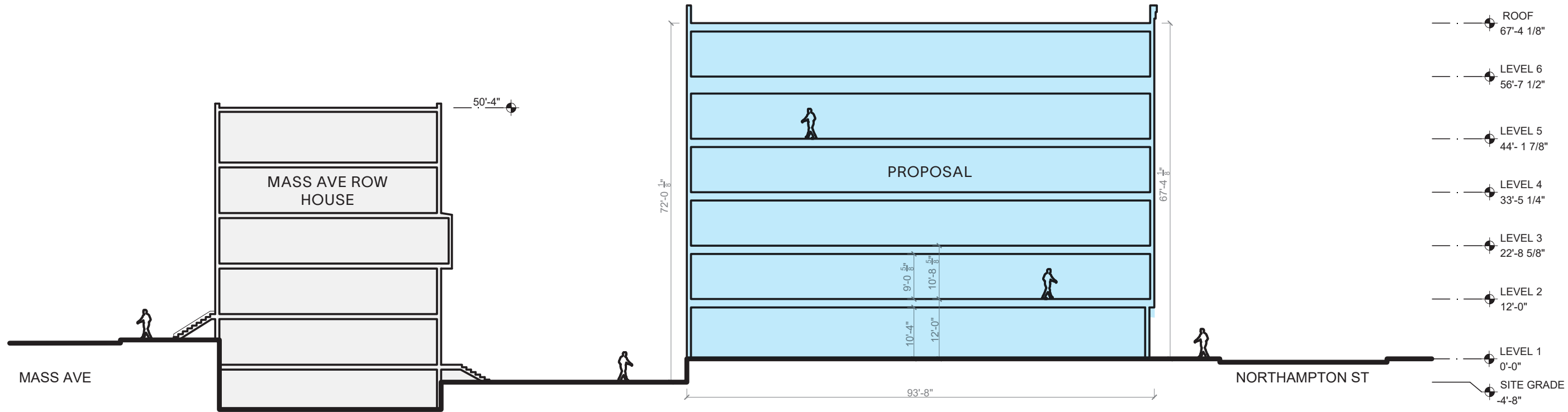

NORTH / SOUTH SECTION