



11 LOUISBURG SQUARE BHAC APPLICATION

FRONT & REAR ROOF

Replace existing roof slates with Vermont Unfading Purple and copper flashings, caps, valleys and gutter in kind. Replace front and rear copper downspouts in kind.

REAR FIFTH FLOOR WINDOWS

Fabricate and install five (5) custom wood double hung windows per shop drawing to replace (5) existing failing windows at rear of fifth (top) floor.

MASONRY

Repoint chimneys to match existing mortar color and texture per BHAC guidelines. Repair masonry corbel/gutter shelf at rear of property to match existing. Furnish and install chimney liners.

FRONT CHIMNEY

Maintain (2) antique copper chimney tops, reset after flue lining is completed. Replace (2) existing inappropriate stainless steel caps with custom copper chimney tops to match existing antique tops. Install sidevent terminal kit at front chimney (marginally visible from Pinckney Street only).

REAR ELL/GARDEN (Not visible from public way)

Replace failing windows on ell at first and second floor. Replace kitchen doors and windows to garden. None of these elements are visible from a public way.

REAR FACADE PHOTOS VIA MOUNT VERNON STREET

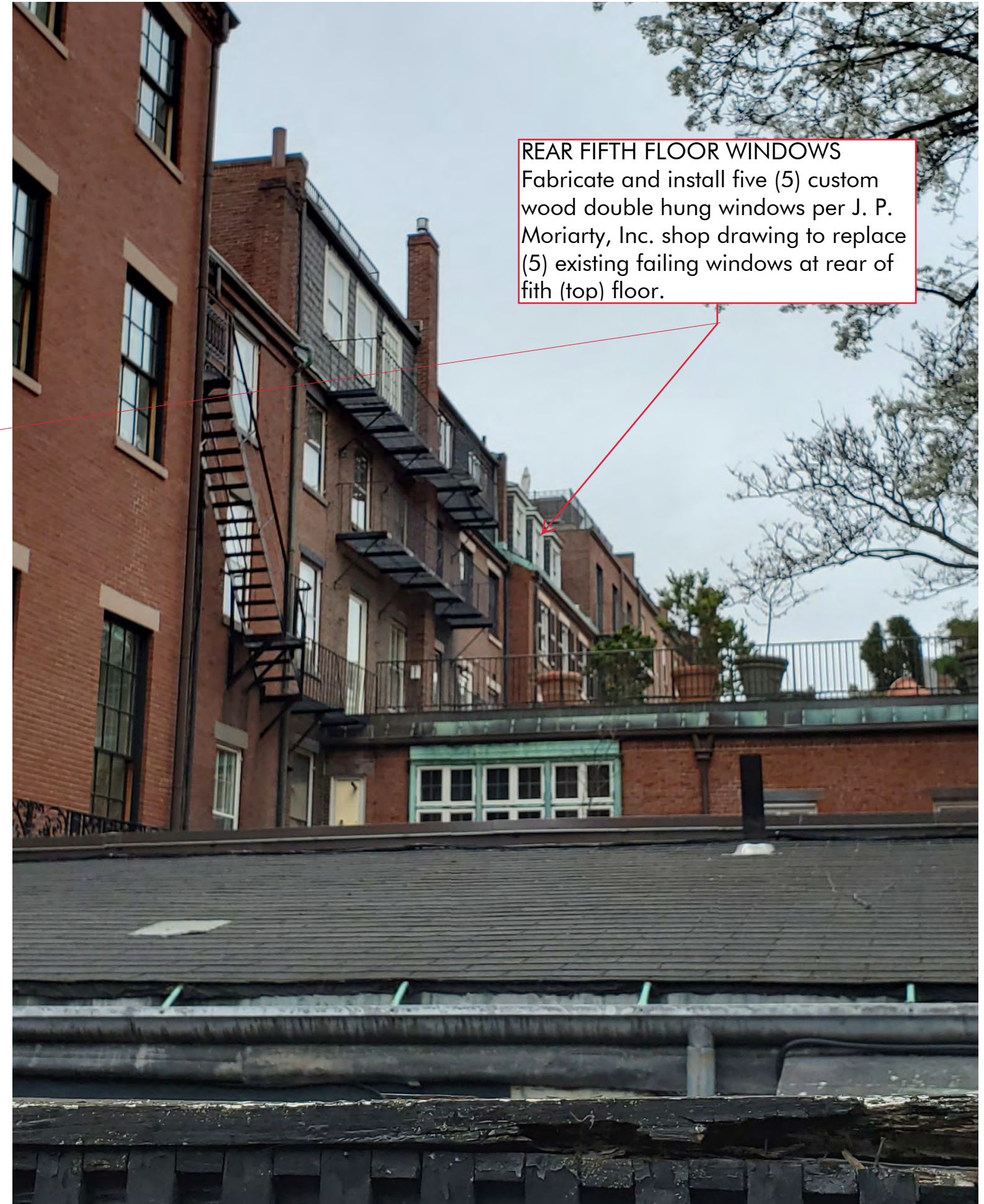

REAR FIFTH FLOOR WINDOWS
Fabricate and install five (5) custom wood double hung windows per J. P. Moriarty, Inc. shop drawing to replace (5) existing failing windows at rear of fifth (top) floor.

REAR FACADE PHOTO & WINDOW SPECIFICATIONS



PHOTO NOT TAKEN FROM A PUBLIC WAY

Replace rear copper downspout in kind

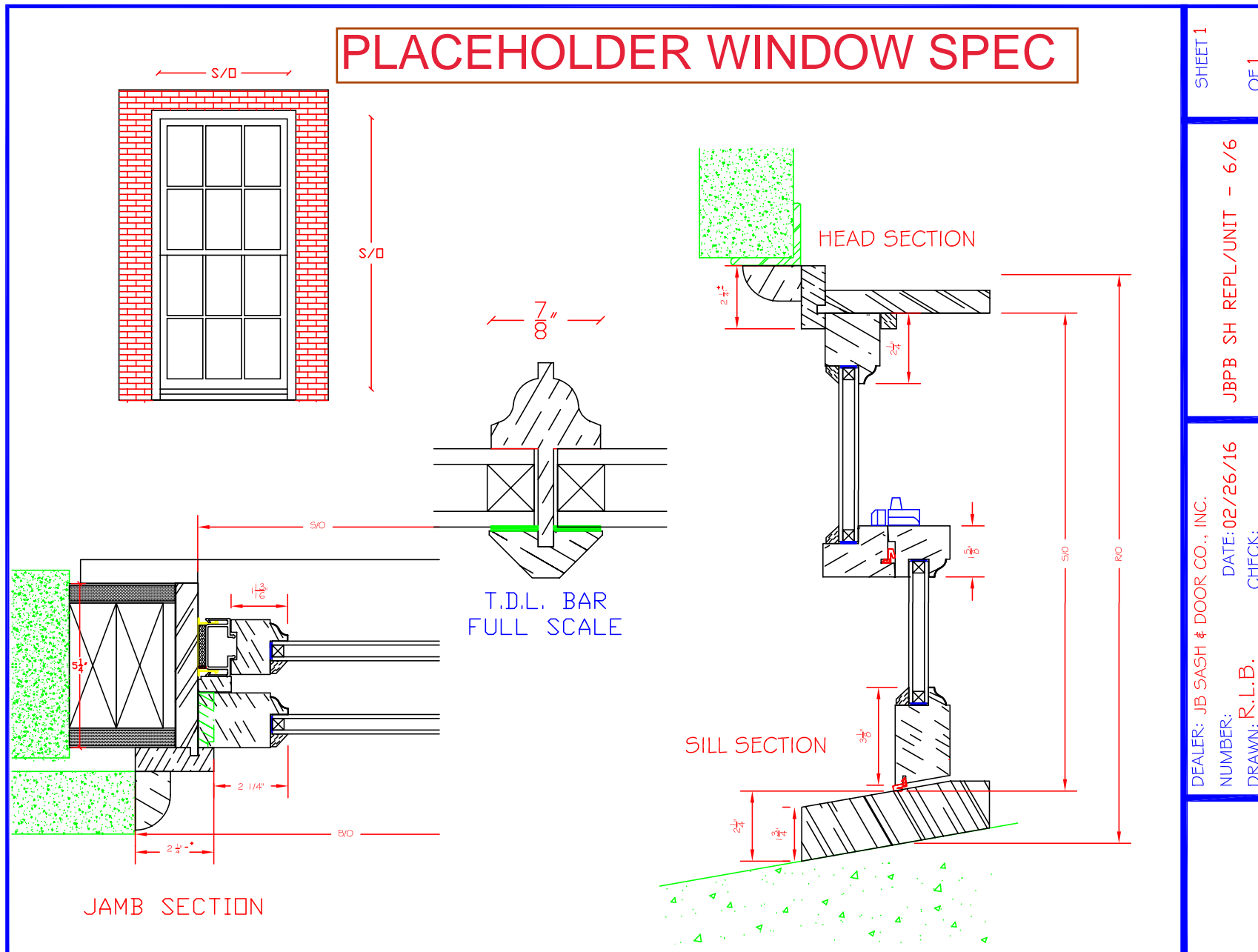

REAR FIFTH FLOOR WINDOWS
 Fabricate and install five (5) custom wood double hung windows per J. P. Moriarty, Inc. shop drawing to replace (5) existing failing windows at rear of fifth (top) floor.



EXISTING FIFTH FLOOR REAR WINDOWS

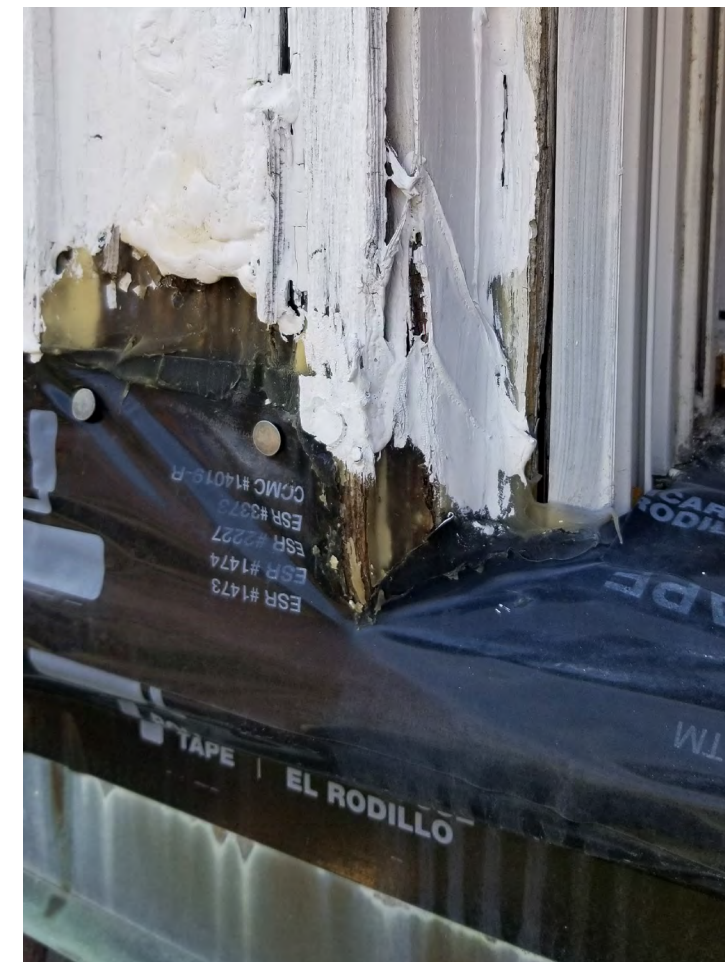
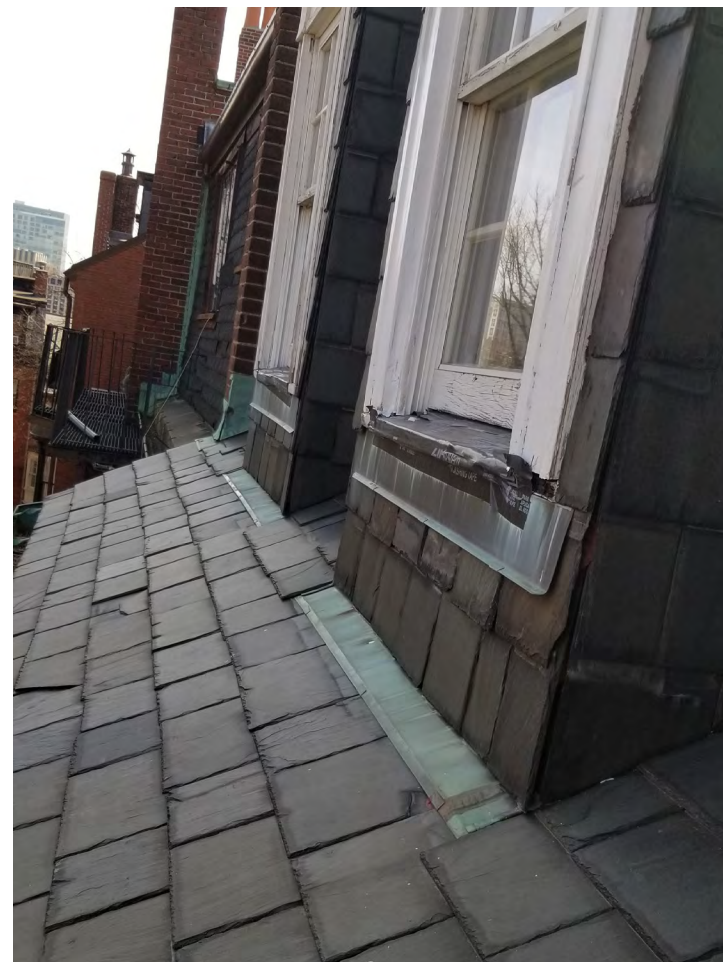

FRONT FACADE PHOTOS VIA PINCKNEY STREET



FRONT CHIMNEY

Maintain (2) antique copper chimney tops, reset after flue lining is completed. Replace (2) existing inappropriate stainless steel caps with custom copper chimney tops to match exiting antique top. Install sidevent terminal kit at front chimney (marginally visible from Pinckney Street only).

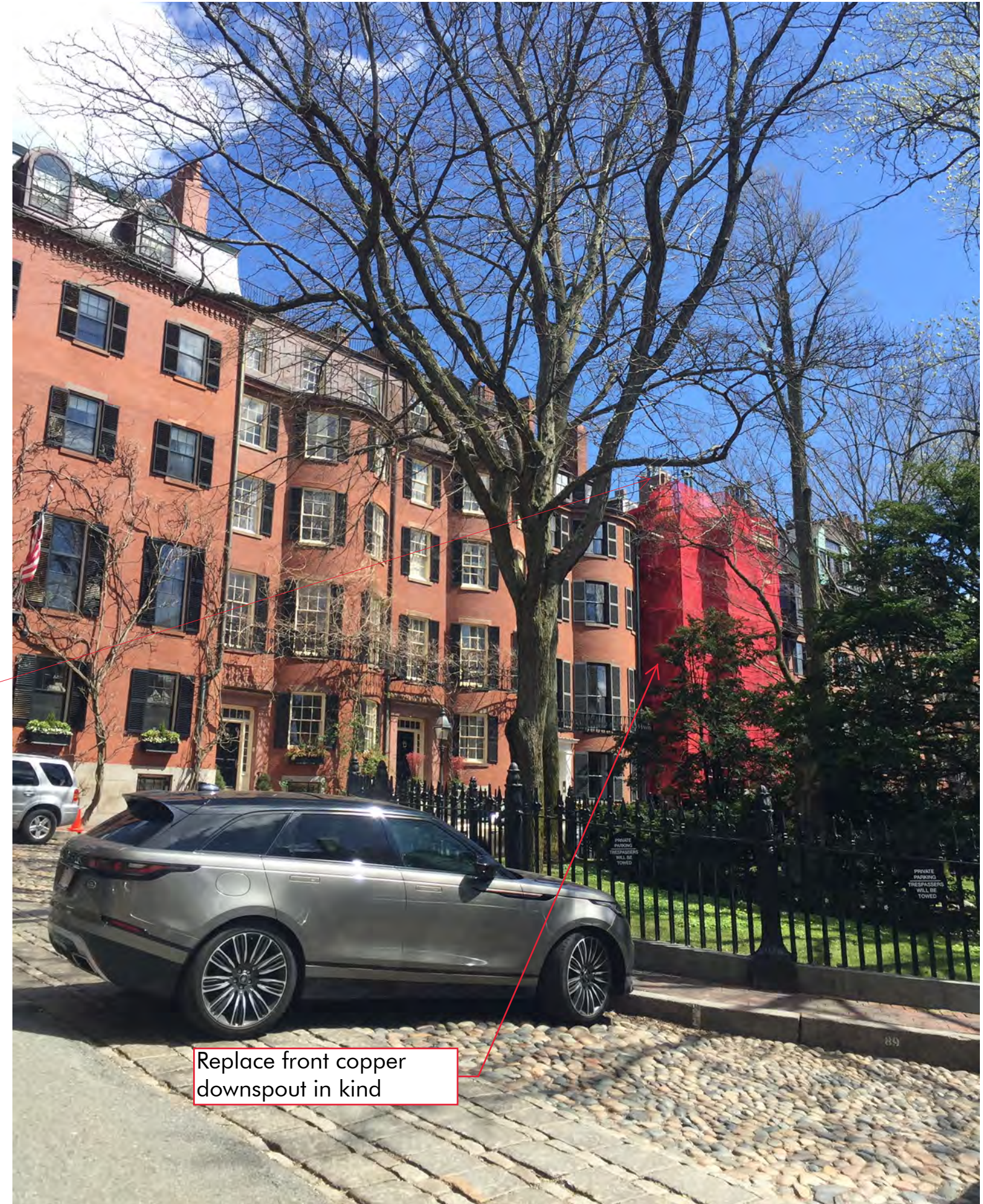

Replace front copper downspout in kind

FRONT CHIMNEY PHOTOS & SIDEWALL VENT SPECIFICATION



PHOTO NOT TAKEN FROM A PUBLIC WAY



720SWK-M Sidewall Co-Linear Terminal Kit for 739M

CSA approved for use **ONLY** with **Valor 739M Fireplaces***
(*For use with Valor 530, 739J and 739-72IL models, use 720SWK kit)

Installation Instructions

WARNING: If the information in these instructions is not followed exactly, a fire or explosion may result causing property damage, personal injury or loss of life.

This kit must be installed or serviced by a qualified installer, service agency or gas supplier.

These instructions are to be used in conjunction with the main installation instructions for the above listed heater models.

Overview

The 720SWK-M Sidewall Co-Linear Terminal Kit allows approved Valor units listed above only to be vented using approved 3-inch flexible vent liners to penetrate an existing masonry solid-fuel burning fireplace and connect to 720SWK-M horizontal termination rather than a vertical termination at the top of the chimney.

Use of this kit requires the vent collar slider plate to be replaced with a vent slider plate having no restrictor (4001133), supplied with this kit except where more than 10'-0" vertical vent run.

Kit Contents

- Sidewall terminal
- Vent slider plate with NO restrictor 4001133

FRONT CHIMNEY

Maintain (2) antique copper chimney tops, reset after flue lining is completed. Replace (2) existing inappropriate stainless steel caps with custom copper chimney tops to match existing antique tops. Install sidevent terminal kit at front chimney (marginally visible from Pinckney Street only).

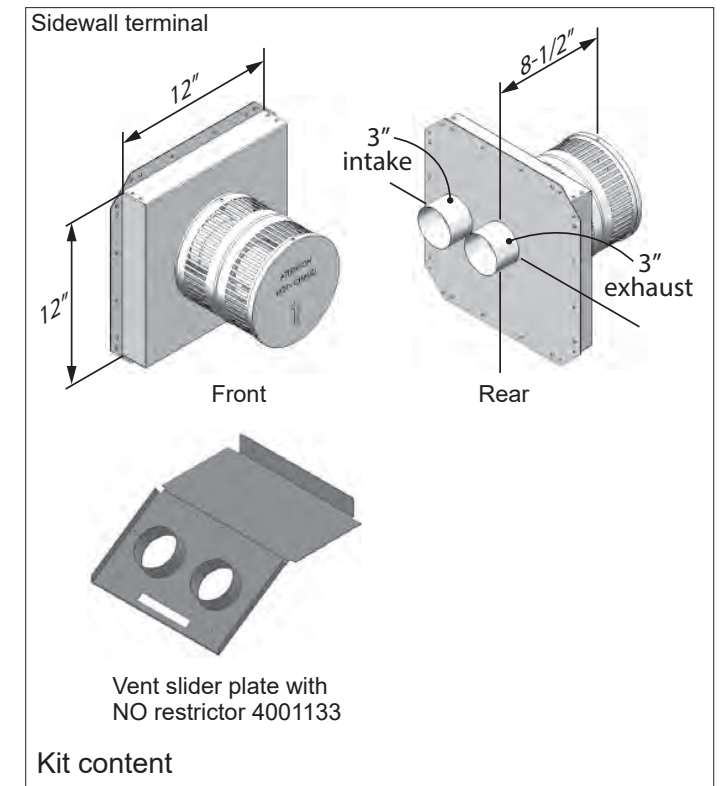

FRONT & REAR ROOF
Replace existing roof slates with Vermont Unfading Purple and copper flashings, caps, valleys and gutter in kind.

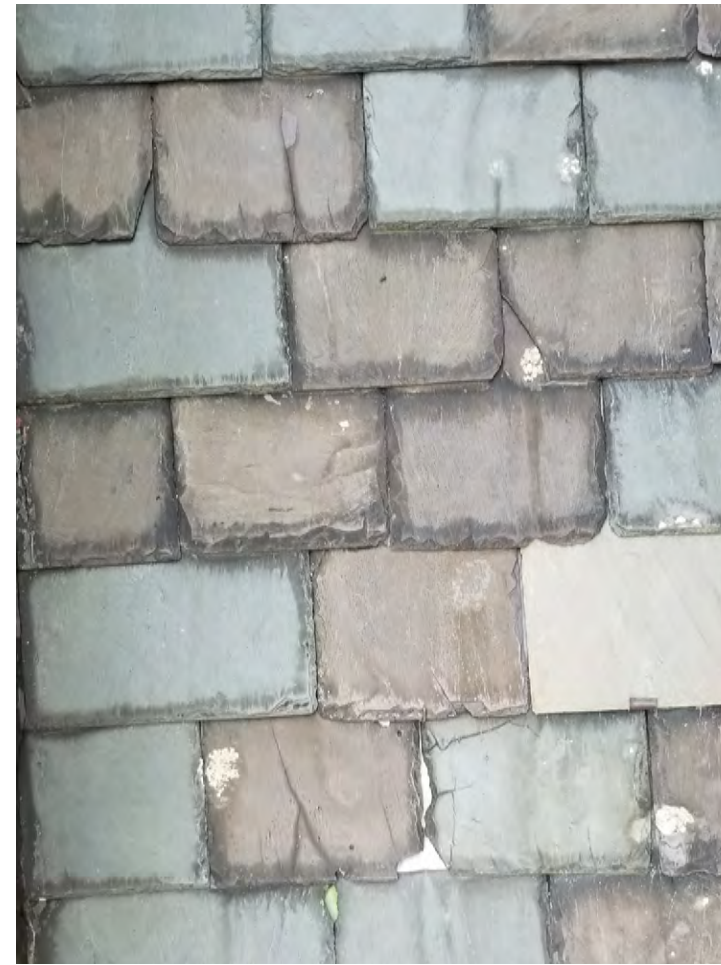
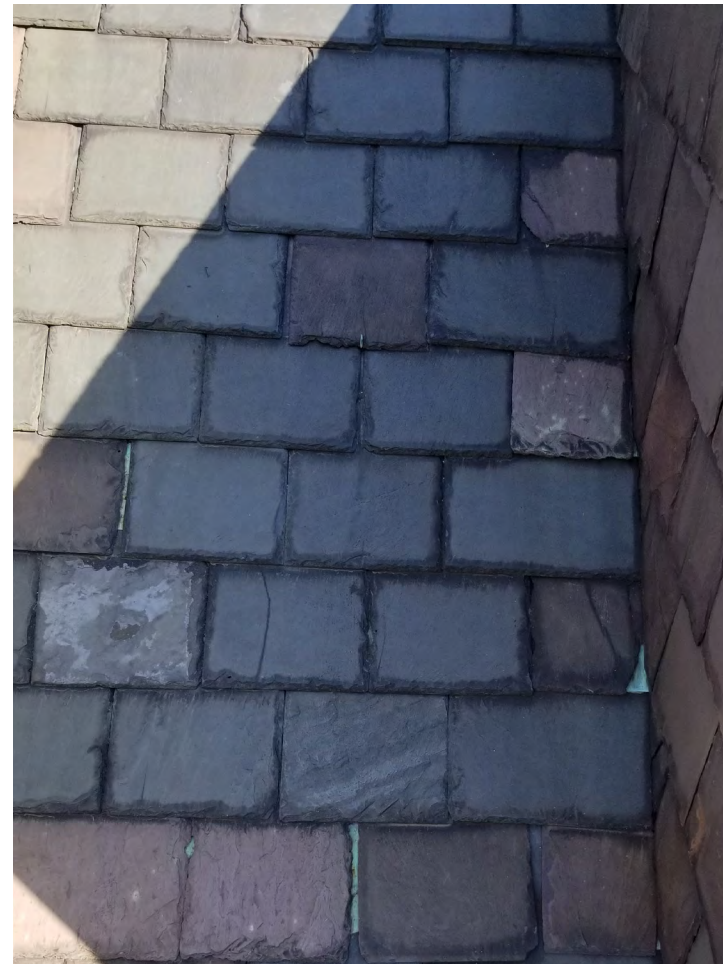
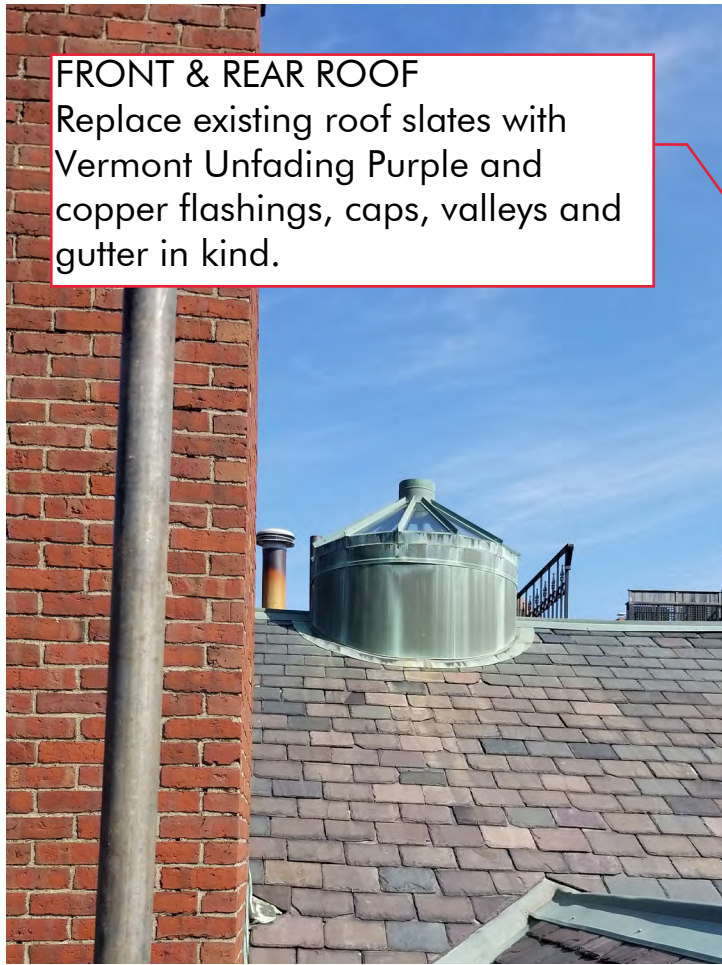

EXISTING PHOTOS OF SLATE ROOF CONDITION

