

Adams House and Keith's
Theatre, Washington St.,
Boston, Mass.





Salvatore's

545

RAMMOUNT
CENTER AT
EMERSON COLLEGE

FINAN
GOV

ONLY
ONE WAY





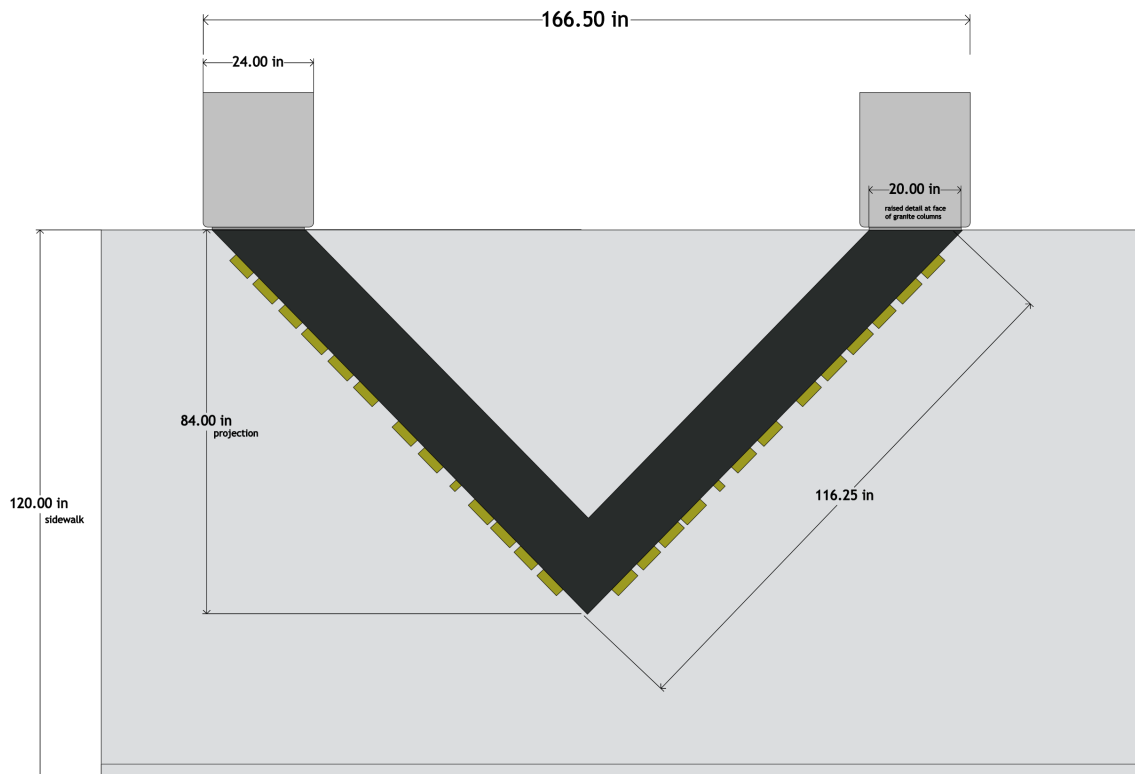
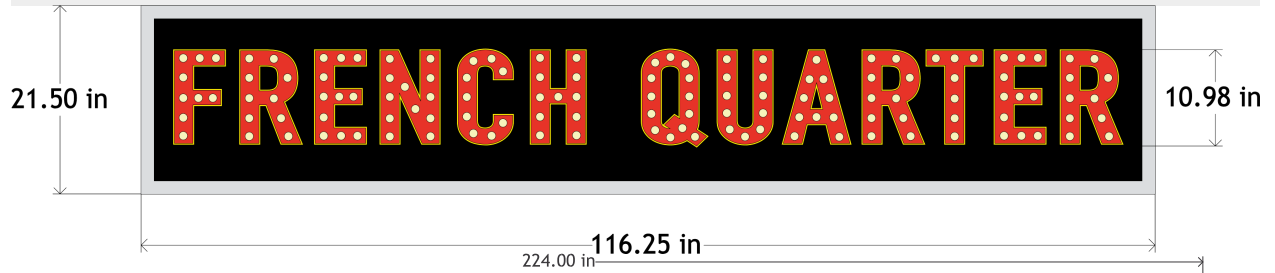
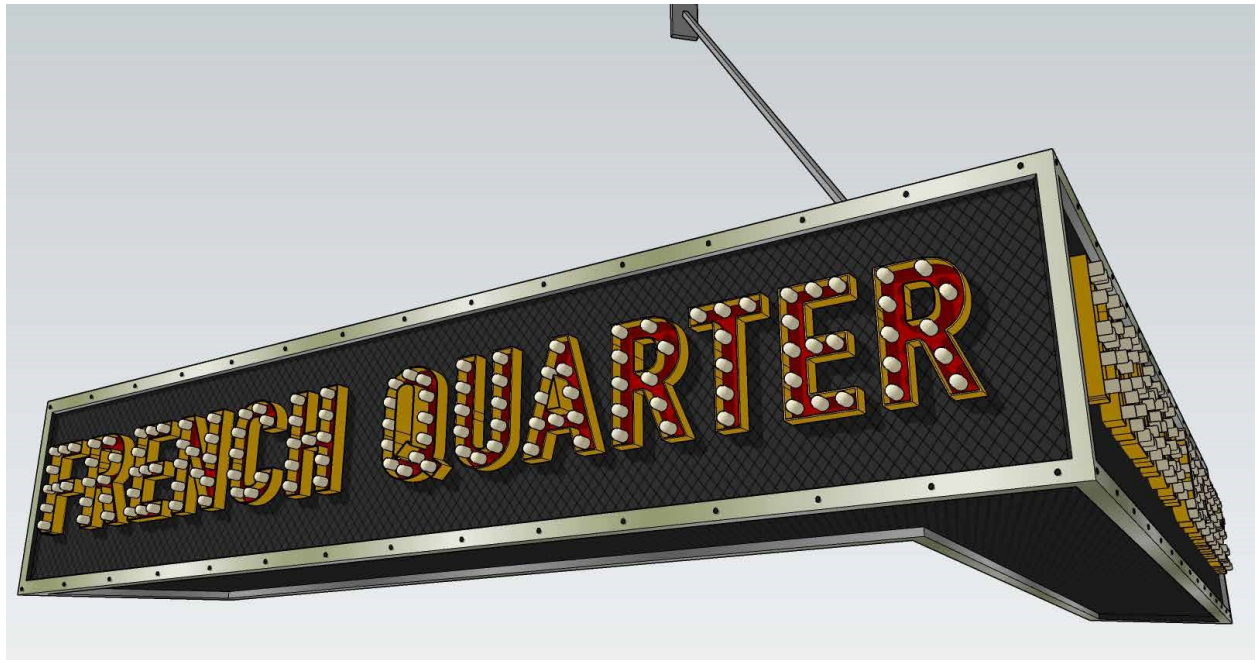

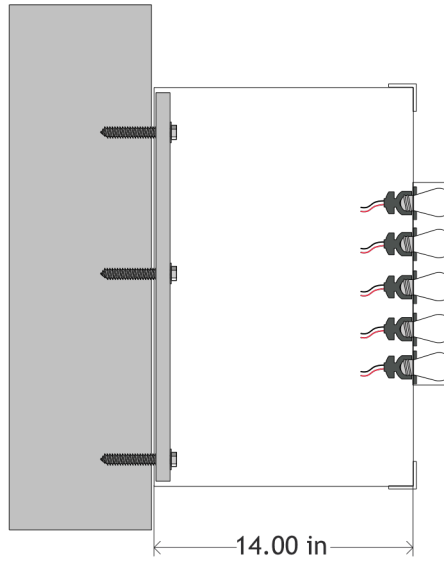
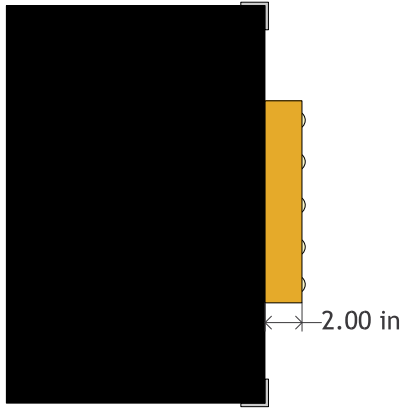

for attachment
at columns

exposed marquee bulbs
warm white

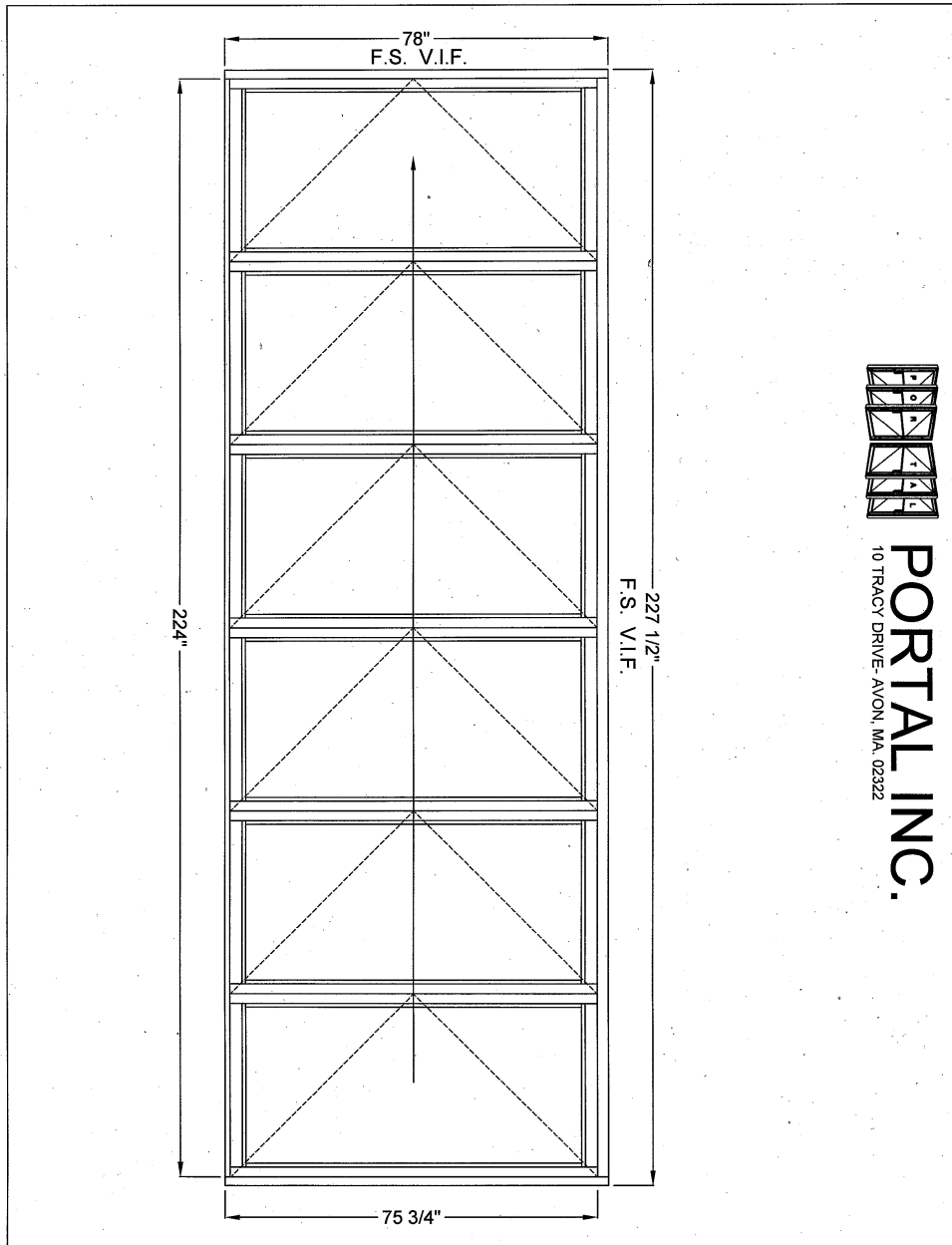

PORTAL INC.
10 TRACY DRIVE - AVON, MA, 02322

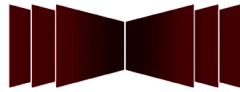

PORTAL INC.
10 TRACY DRIVE AVON, MA 02322

TYPICAL MANUAL FOLDING WINDOW ELEVATION:

(1/2" = 1'-0")

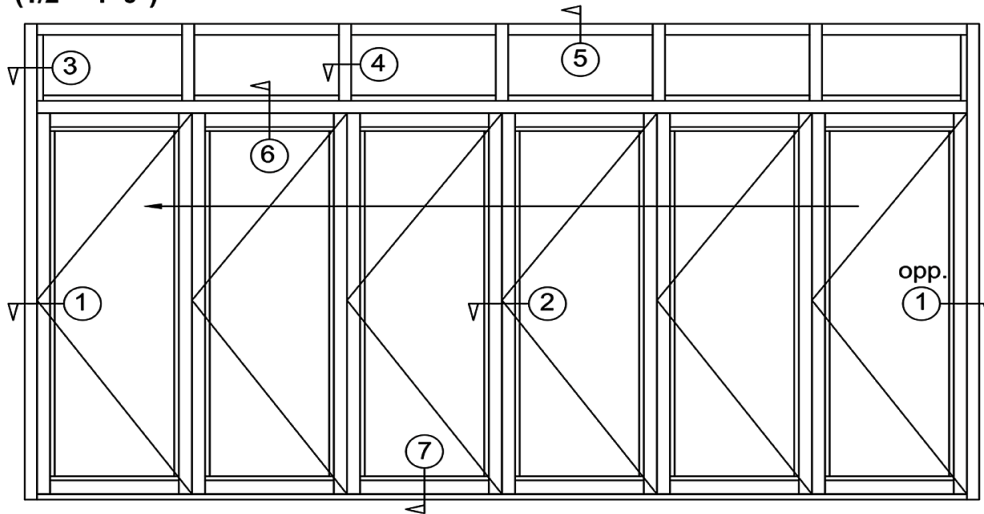

SPECIFICATIONS FOR FOLDING WINDOWS & FRAMING

Portal folding windows shall be constructed of extruded aluminum shapes for stiles and rails. All aluminum shall be 6063-T5 with all exposed surfaces given a #204 R1 clear anodized finish or #313 dark bronze anodized finish. Several standard painted finishes available also. Wall thickness of stiles and rails shall be a minimum of $\frac{1}{8}$ ". The operable panel thickness shall be $1\frac{3}{4}$ ". Stiles and rails shall be bolted and electric arc welded to heavy anchors at all four corners. Meeting stiles of all folding panels shall be weather-stripped. All glazing beads shall have neoprene inserts for clean, puttyless snap in glazing.

Exterior glazing beads shall be non removable. Butt hinged folding panels shall be furnished with $\frac{1}{4}$ " aluminum hinge reinforcing plates. All exterior operable panels to be furnished with standard flushbolt style locks and maximum security lock and adjustable door leveling hinges for minimum clearance adjustments.

Frames shall be constructed of seamless extruded aluminum tubes of 6063-T5 Alloy with anodized or standard painted surface. The basic shapes shall measure $1\frac{3}{4}$ " x $4\frac{1}{2}$ " or 2" x $4\frac{1}{2}$ ". Frames for offset hung doors shall be furnished with $\frac{1}{4}$ " aluminum hinge reinforcement plates and weather-stripped doorstops.

PH: 800-966-3030 / www.portalincorporated.com

FOLD-1

