

Google Maps 45 W Newton St



Map data ©2019 Google 200 ft



Contract - Detailed

Pella Windows and Doors
 HIC# 183279 / Tax ID# 26-1413183 45 Fondi Road
 Haverhill, MA 01832
Phone: (978) 373-2500 **Fax:**



Sales Rep Name: Griseto, Anthony
Sales Rep Phone: 978-490-9666
Sales Rep Fax:
Sales Rep E-Mail: GRISETOAC@pellaboston.com

Customer Information	Project/Delivery Address	Order Information
Primary Phone: Mobile Phone: Fax Number: E-Mail: tiggem@aol.com Great Plains #: Customer Number: Customer Account:	Stebbins, Meg, Boston, MA Lot # County:	Quote Name: 5 Windows 1 Door Order Number: 741 Quote Number: 11697460 Order Type: Installed Sales Payment Terms: Deposit/C.O.D. Tax Code: MA TAX 6.25 Quoted Date: 8/11/2019

Line #	Location	Attributes	Item Price	Qty	Ext'd Price
10	Delivery	Delivery/Setup - Delivery/Setup	\$252.00	1	\$252.00

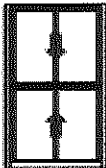
For more information regarding the finishing, maintenance, service and warranty of all Pella® products, visit the Pella® website at www.pella.com

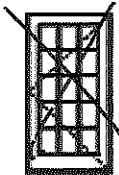
Line #	Location:	Attributes			
15	House Windows	Architect, Replacement Double Hung, Black	<u>Item Price</u>	<u>Qty</u>	<u>Ext'd Price</u>
			\$3,282.16	5	\$16,410.80
	 <p>Viewed From Exterior</p>	<p>PK # 2042</p> <p>1: SizeNon-Standard Size Double Hung, Equal General Information: Standard, Luxury, Wood, Pine, 4 3/4", 3 1/4" Exterior Color / Finish: Primed, Standard Enduraclad, Black Interior Color / Finish: Unfinished Interior Sash / Panel: Putty Glaze, Ogee, Standard, No Sash Lugs Glass: Insulated Dual Low-E AdvancedComfort Low-E Insulating Glass Argon Non High Altitude Hardware Options: Spoon-Style Lock, Matte Black, No Window Opening Control Device, No Limited Opening Hardware, No Sash Lift, No Integrated Sensor Screen: Half Screen, Standard EnduraClad, Black, Standard, InView™ Performance Information: U-Factor 0.26, SHGC 0.25, VLT 0.46, CPD PEL-N-233-00279-00001, Performance Class CW, PG 50, Calculated Positive DP Rating 50, Calculated Negative DP Rating 50, Year Rated 08 11, Egress Does not meet typical United States egress, but may comply with local code requirements Grille: iLT, No Custom Grille, 7/8", Traditional (2W1H / 2W1H), Putty Glaze, Ogee</p>			
		3rd Story and Above Ext - 3rd Story and Above Ext	Qty	1	
		City Logistics - City Logistics	Qty	1	
		Extra Layer EXT - Extra Layer Exterior Trim	Qty	1	
		Historic Window Install - Historic Window Install	Qty	1	
		PI_Insulate Pockets - Insulate Weight Pockets	Qty	1	
		Lead Safe Install - Lead Safe Install	Qty	1	
		Paint/Stain Ext Trim - Paint/Stain Exterior Trim Only (Wood)	Qty	1	
		Paint Window Int - Paint Window Interior	Qty	1	
		Paint/Stain Int Trim Wood - Paint/Stain Interior Trim Only (Wood)	Qty	1	

Line #	Location:	Attributes			
20	Rear Door	Architect, Inswing Door, French, Left, Black	<u>Item Price</u>	<u>Qty</u>	<u>Ext'd Price</u>
			\$7,452.46	1	\$7,452.46
	 <p>Viewed From Exterior</p>	<p>PK # 2042</p> <p>1: Left Inswing Door General Information: Standard, Clad, Pine, 6 3/4", 5 7/16", Standard Sill, Black Finish Sill, Black Composite Threshold Exterior Color / Finish: Painted, Standard Enduraclad, Black Interior Color / Finish: Unfinished Interior Sash / Panel: Ogee, Ogee, Standard Glass: Insulated Dual Tempered Low-E AdvancedComfort Low-E Insulating Glass Argon Non High Altitude Hardware Options: Standard, Matte Black, Order Handle Set, Multipoint Lock, No Integrated Sensor Screen: No Screen Performance Information: U-Factor 0.26, SHGC 0.19, VLT 0.33, CPD PEL-N-218-04135-00001, Performance Class LC, PG 55, Calculated Positive DP Rating 55, Calculated Negative DP Rating 70, Year Rated 08 Grille: iLT, No Custom Grille, 7/8", Traditional (3W5H), Ogee, Ogee</p>			
					

For more information regarding the finishing, maintenance, service and warranty of all Pella® products, visit the Pella® website at www.pella.com



UNIT SECTIONS
Aluminum-Clad Exterior
LX Double-Hung

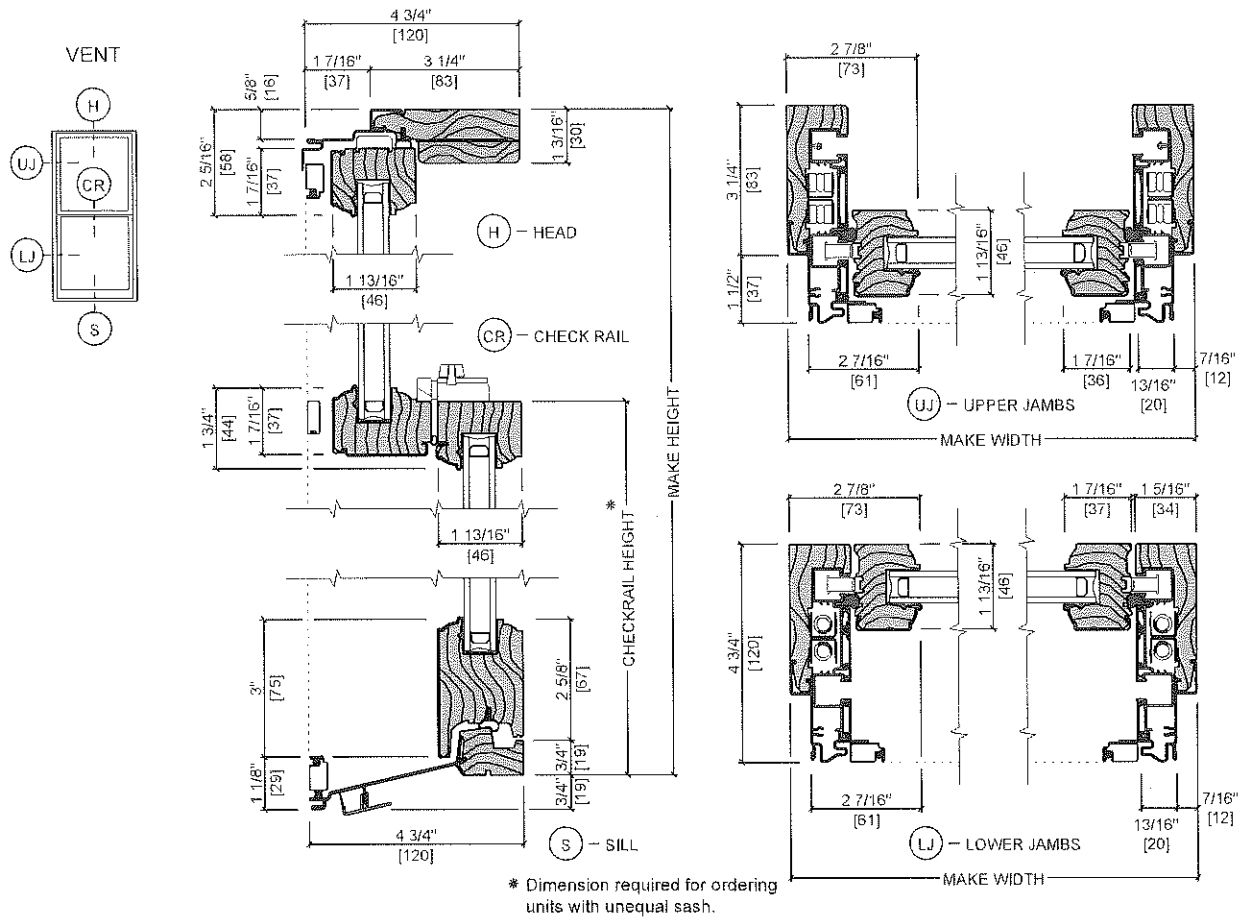

Scale 3" = 1' 0"

All dimensions are approximate.



Architect Series® Traditional In-Swing Patio Door

Unit Sections - Aluminum-Clad Ogee Exterior Glazing Profile

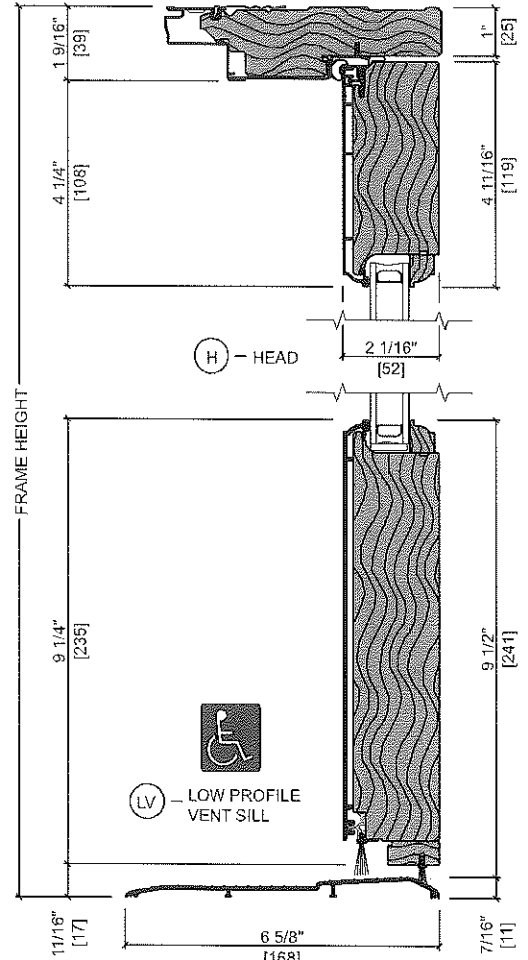
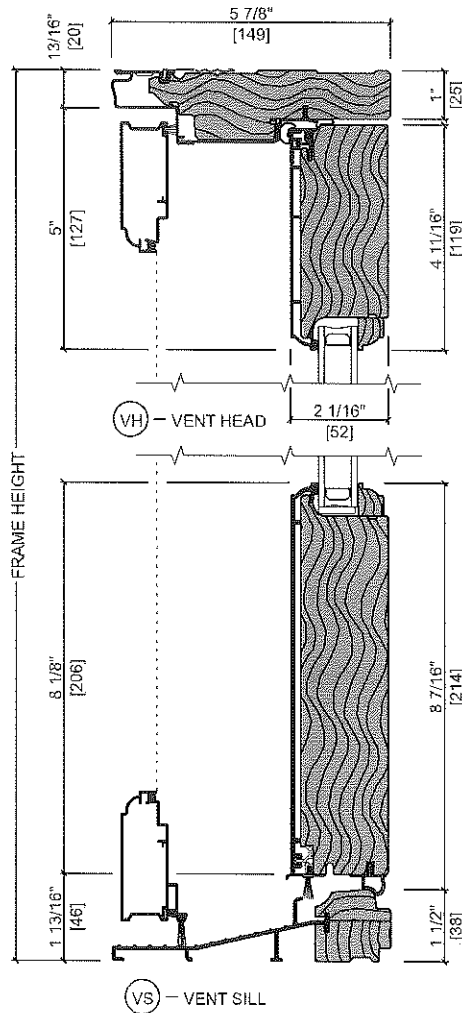
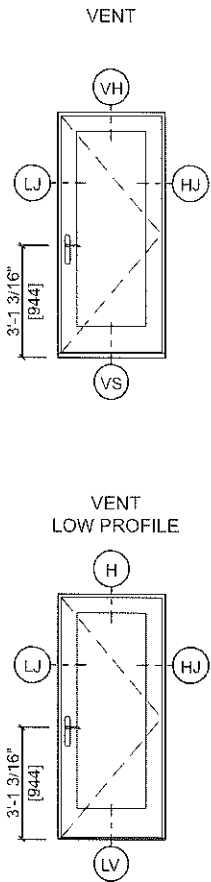

Handle Height Dimension shown is from bottom of unit frame to door handle. Installation method used and finished flooring conditions will cause handle height to vary. Doors not using the standard Pella multi-point lock and hardware (specified as 'No lock/No Bore') are not Hallmark certified.

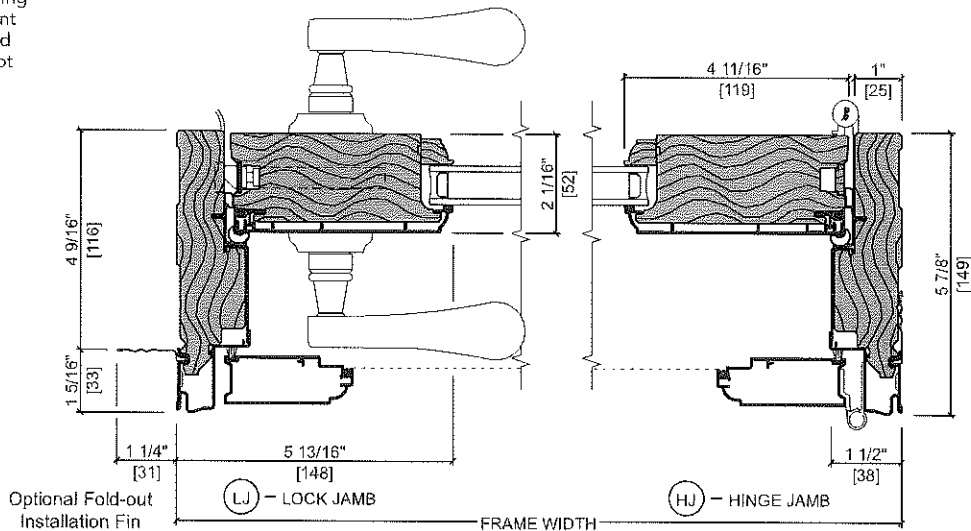

Scale 3" = 1' 0"

All dimensions are approximate.

Water resistance is 0 psf for doors with low profile sill



DOUBLE-HUNG

GRILLE TYPES

Typical Grille Profiles



Integral Light Technology[®] Grilles

Ogee Grilles

Clad Exterior - Wood Interior₂

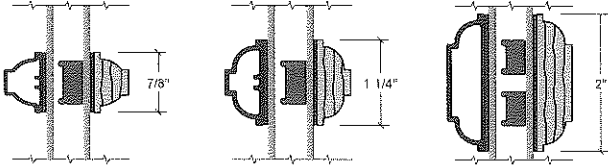

Ogee Grilles

Wood Exterior - Wood Interior

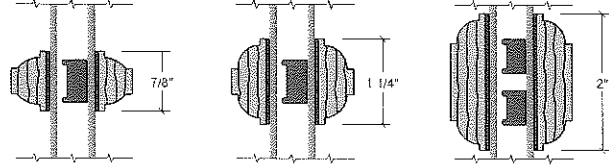

Putty Glaze and Ogee Grilles

Clad Exterior - Wood Interior_{1, 2}

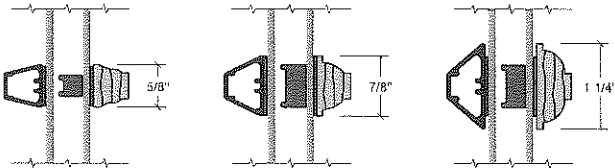

Putty Glaze and Ogee Grilles

Wood Exterior - Wood Interior₁

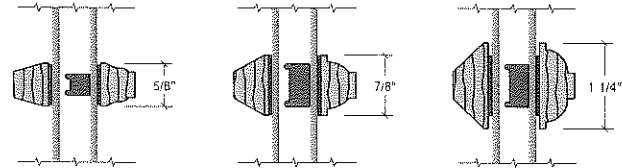

Roomside Removable Grilles

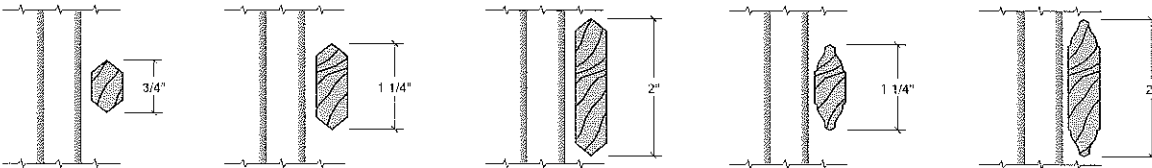

Grilles-Between-the-Glass

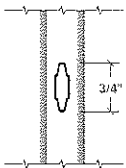

(1) Additional profile options Putty Exterior/Putty Interior, Ogee Exterior/Putty Interior are also available.

(2) Available in Pine, Mahogany, Alder or Douglas Fir to match complete unit.

93"

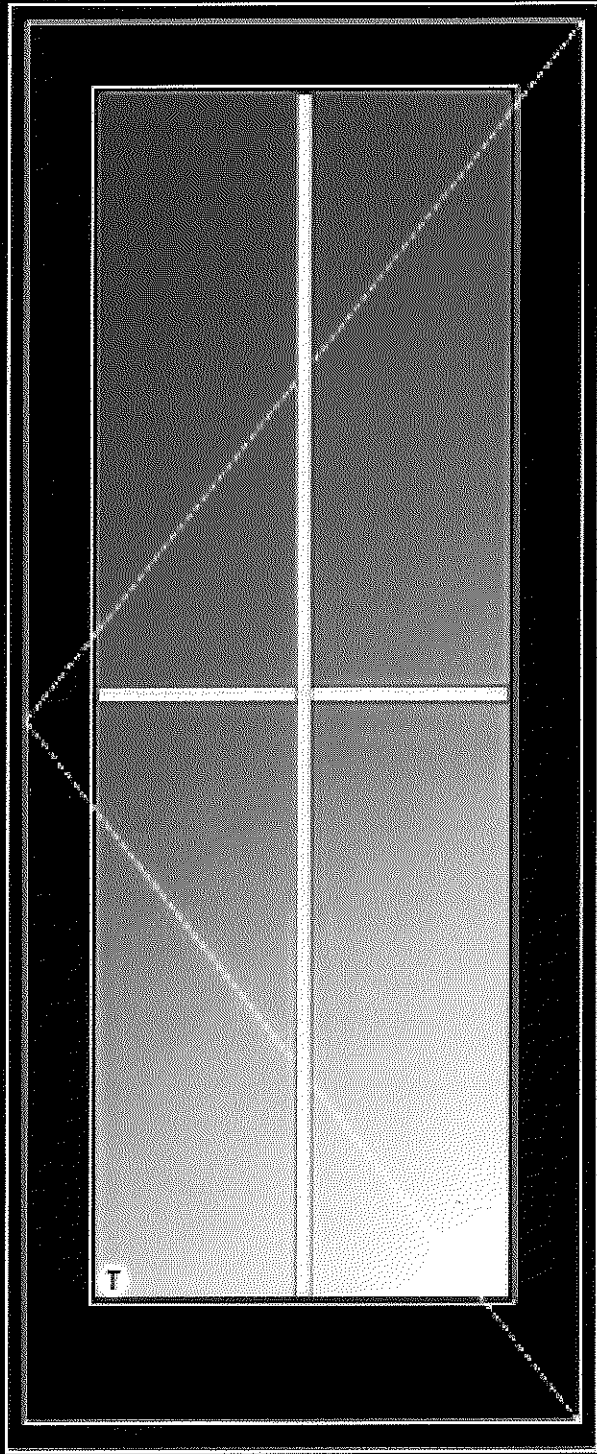

37.875"

